

General Specifications

B Electrical Capacity (Resistive Load)

| | |
|------------------------------|--|
| Power Level (silver): | Maximum rating varies by model number MN12, MN22: 6A @ 125V AC, 3A @ 250V AC, 4A @ 30V DC MN13, MN15, MN18, MN19, MN23, MN25: 6A @ 125V AC, 3A @ 250V AC, 3A @ 30V DC MN28, MN29: 4A @ 125V AC, 3A @ 250V AC, 3A @ 30V DC MN24, MN26, MN27: 3A @ 125V AC, 2A @ 250V AC, 2A @ 30V DC MN32: 4A @ 125V AC, 2A @ 250V AC, 3A @ 30V DC MN33, MN35, MN38, MN39: 4A @ 125V, 2A @ 250V, 2A @ 30V Recommended minimum voltage/current: 0.1A @ 2V AC/DC 4A @ 30V DC for On-None-On; 3A @ 30V DC for all other circuits |
| Logic Level (gold): | 0.4VA maximum @ 28V AC/DC maximum (Applicable Range 0.1mA ~ 0.1A @ 20mV ~ 28V) |

Other Ratings

| | |
|-------------------------------|--|
| Contact Resistance: | 10 milliohms maximum for silver; 20 milliohms maximum for gold |
| Insulation Resistance: | 1,000 megohms minimum @ 500V DC |
| Dielectric Strength: | 1,000V AC minimum between contacts for 1 minute minimum; 1,500V AC minimum between contacts and case for 1 minute minimum |
| Mechanical Life: | 50,000 operations minimum |
| Electrical Life: | 25,000 operations minimum for silver; 50,000 operations minimum for gold |
| Angle of Throw: | 25° |

Materials & Finishes

| | |
|--|---|
| Actuator Clip & Mounting Frame: | Stainless steel or beryllium copper for spring |
| Body Frame: | Stainless steel |
| Case: | Diallyl phthalate resin (UL94V-0) |
| Movable Contacts: | Silver alloy (code W); copper with gold plating (code G) |
| Stationary Contacts: | Silver with silver plating (code W); copper or brass with gold plating (code G) |
| Terminals: | Copper or brass with silver plating; or copper or brass with gold plating |

Environmental Data

| | |
|------------------------------|--|
| Operating Temp Range: | -30°C through +85°C (-22°F through +185°F) |
| Humidity: | 90 ~ 95% humidity for 240 hours @ 40°C (104°F) |
| Vibration: | 10 ~ 55Hz with peak-to-peak amplitude of 1.5mm traversing the frequency range & returning in 1 minute; 3 right angled directions for 2 hours |
| Shock: | 500m/s ² acceleration (tested in 6 right angled directions, with 5 shocks in each direction) |

Processing

| | |
|-------------------|--|
| Soldering: | Wave Soldering (PC version) for Gold: See Profile A in Supplement section. Manual Soldering for Gold: See Profile A in Supplement section. Wave Soldering (PC version) for Silver: See Profile B in Supplement section. Manual Soldering for Silver: See Profile B in Supplement section. Note: Actuator must be in OFF (center) position while soldering. |
| Cleaning: | These devices are not process sealed. Hand clean locally using alcohol based solution. |

Standards & Certifications

| | |
|--------------------------------|---|
| Flammability Standards: | UL94V-0 for case |
| UL: | Contact NKK Switches for UL or CUL marking option requirements. |

Distinctive Characteristics

Three methods of panel mounting: flat frame for flush with face or subpanel, snap-in, and PCB.

High insulating barriers increase isolation of circuits in multipole devices and provide added protection to contact points.

The molded diallyl phthalate case has a UL94V-0 flammability rating.

Epoxy sealed terminals prevent entry of solder flux and other contaminants.

Prominent external insulating barriers increase insulation resistance and dielectric strength.

Bias guard prevents misalignment of contacts; interlocking of actuator block with rocker and internal guide does not allow transmission of diagonal force on rocker to reach contact mechanism.

Clinching of the frame to the case well above the base and terminals provides 1,500V dielectric strength.

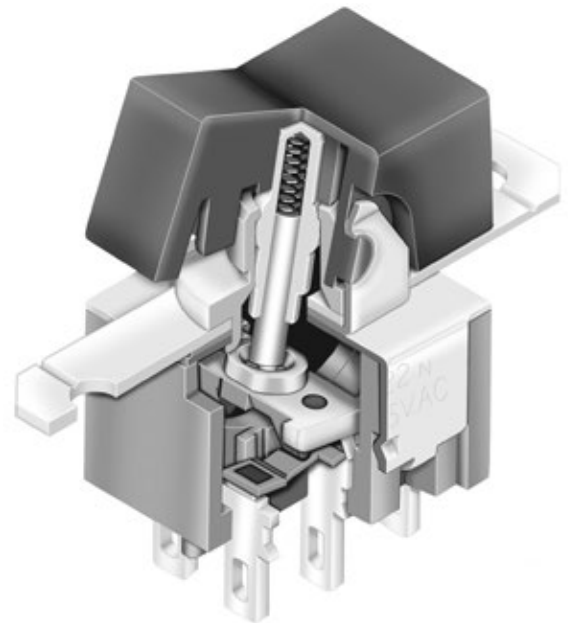

Actual Size



- Toggles
- B** Rockers
- Pushbuttons
- Illuminated PB
- Programmable
- Keylocks
- Rotaries
- Slides
- Tactiles
- Tilt
- Touch
- Indicators
- Accessories
- Supplement

TYPICAL SWITCH

Toggles

Rockers **B**

Pushbuttons

Illuminated PB

Programmable

Keylocks

Rotaries

Slides

Tactiles

Tilt

Touch

Indicators

Accessories

Supplement

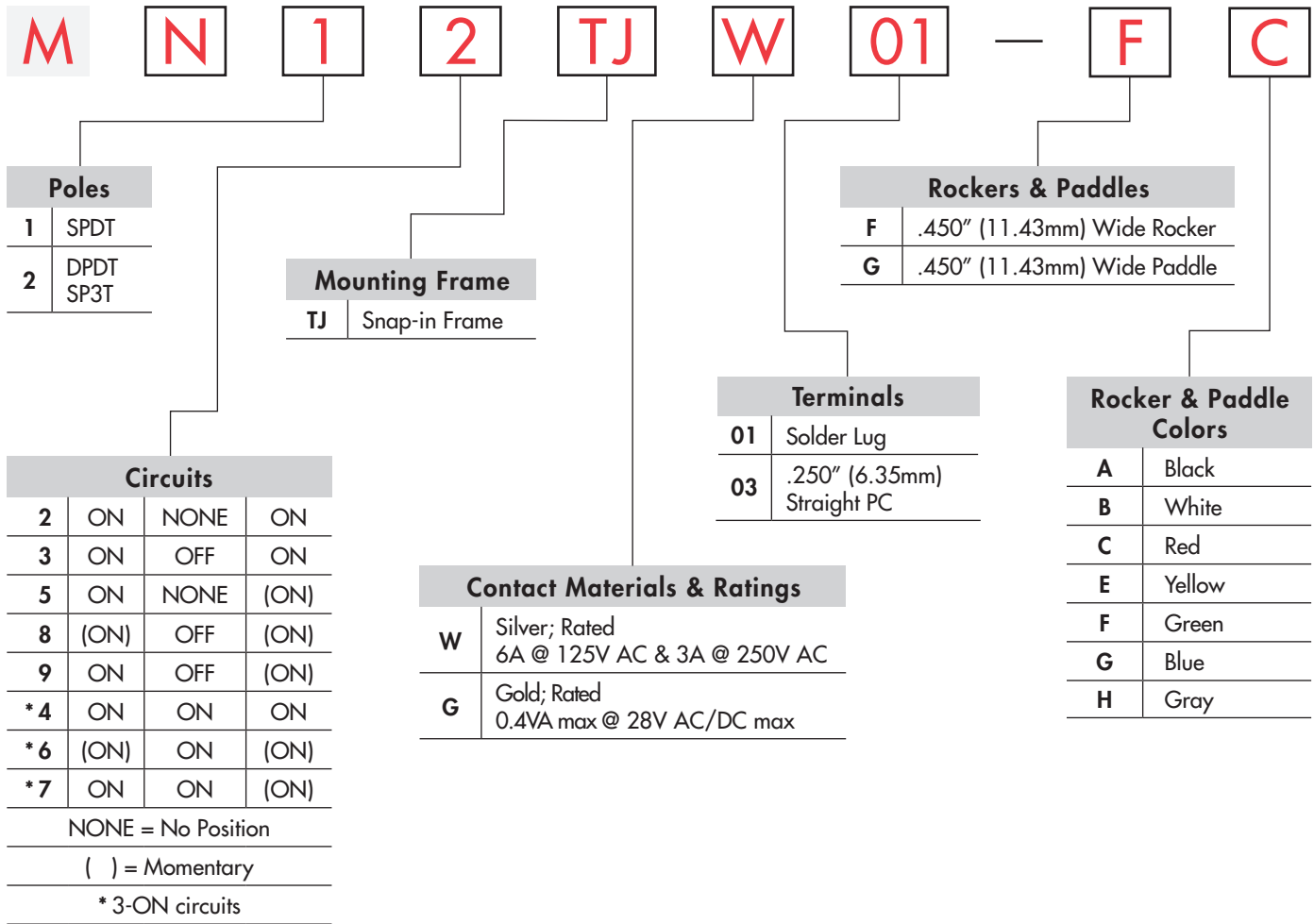

DESCRIPTION FOR TYPICAL ORDERING EXAMPLE

MN12TJW01-FC-1A

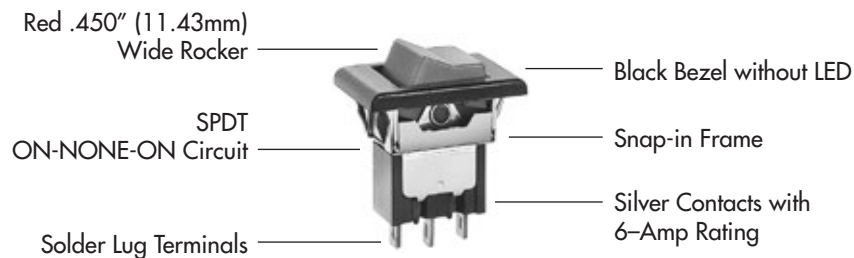

ORDERING EXAMPLE

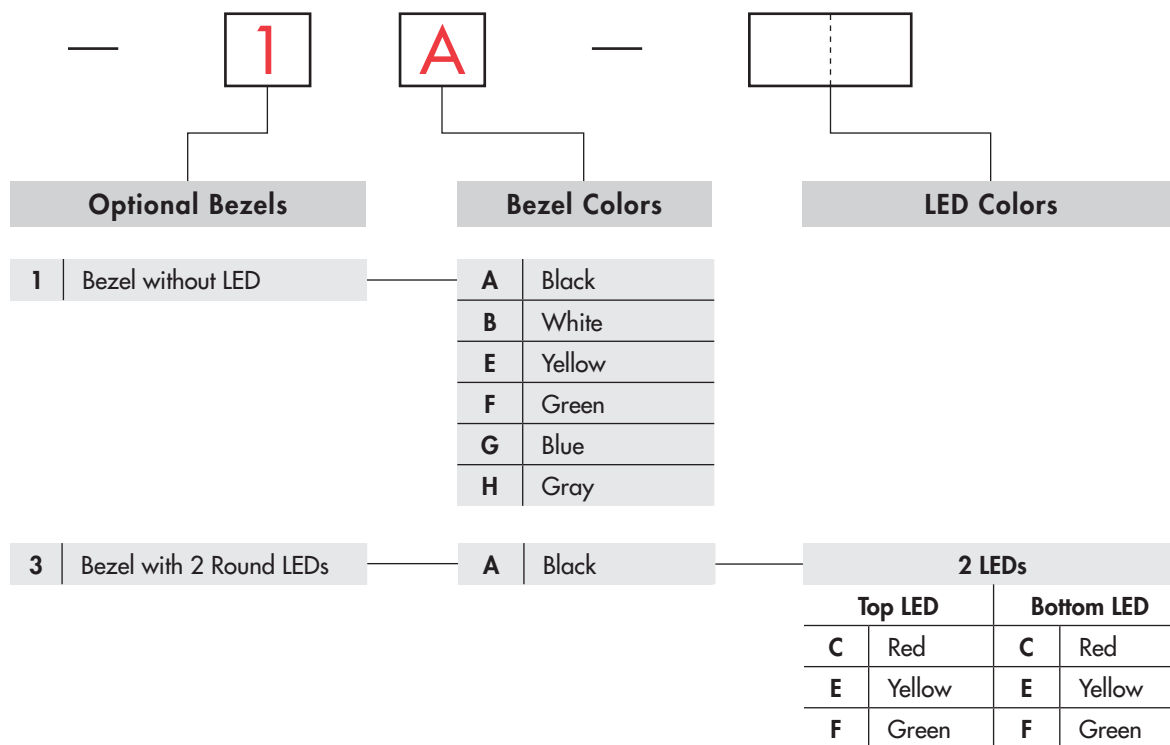

DESCRIPTION FOR TYPICAL ORDERING EXAMPLE

MN12TJW01-FC-3A-CF

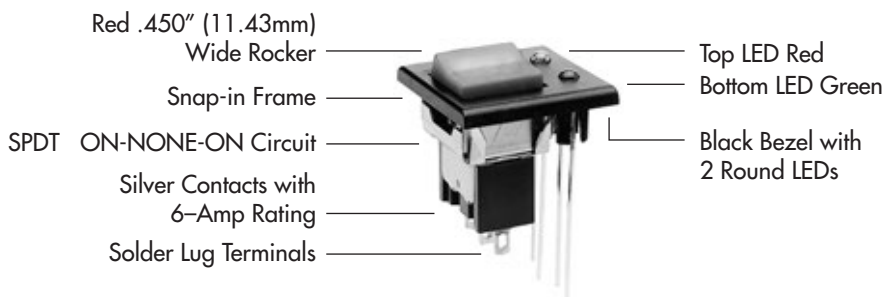

Toggle

Rockers **B**

Pushbuttons

Programmable Illuminated PB

Keylocks

Rotaries

Slides

Tactiles

Tilt

Touch

Indicators

Accessories

Supplement

POLES & CIRCUITS

| Pole | Model | Rocker Position | | | Connected Terminals | | | Throw & Schematics |
|------|--------------------------------------|------------------------------------|-----------------------------------|----------------------------------|---------------------|--------|---------|--|
| | | Down | Center | Up | Down | Center | Up | |
| | | NONE = No Position () = Momentary | | | | | | |
| | | | | | | | | Note: Terminal numbers are not actually on the switch. |
| SP | MN12 MN13 MN15 MN18 MN19 | ON ON ON (ON) ON | NONE OFF NONE OFF OFF | ON ON (ON) (ON) (ON) | 2-3 | OPEN | 2-1 | SPDT |
| DP | MN22 MN23 MN25 MN28 MN29 | ON ON ON (ON) ON | NONE OFF NONE OFF OFF | ON ON (ON) (ON) (ON) | 2-3 5-6 | OPEN | 2-1 5-4 | DPDT |

For 3 Throw (3-On)

| Pole | Model | Connected Terminals & Schematic | | | External Connection |
|------|----------------------|---------------------------------|----------------|--------------------|---|
| | | Down | Center | Up | |
| SP | MN24 MN26 MN27 | ON (ON) ON | ON ON ON | ON (ON) (ON) | <p>The SP3T model utilizes a double pole base.</p> <p>External connection must be made during field installation.</p> |
| | | | | | |
| | | 2-3 5-6 | 2-3 5-4 | 2-1 5-4 | |

MOUNTING FRAME

TJ

Snap-in Frame

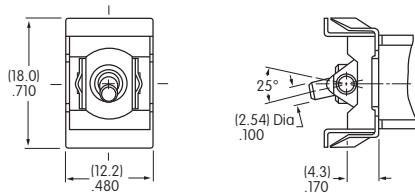

Panel Cutout for Single Pole without Bezel

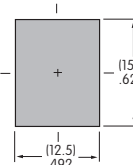

Panel Cutout for Double Pole without Bezel

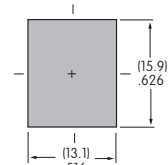

Panel Thickness without Bezel: .039" ~ .126" (1.0mm ~ 3.2mm)
 Panel Thickness with Bezel: .039" ~ .098" (1.0mm ~ 2.5mm)

CONTACT MATERIALS & RATINGS

W

Silver Power Level

MN12, MN22: 6A @ 125V AC, 3A @ 250V AC, 4A @ 30V DC
 MN13, MN15, MN18, MN19, MN23, MN25: 6A @ 125V AC, 3A @ 250V AC, 3A @ 30V DC
 MN28, MN29: 4A @ 125V AC, 3A @ 250V AC, 3A @ 30V DC
 MN24, MN26, MN27: 3A @ 125V AC, 2A @ 250V AC, 2A @ 30V DC

G

Gold

Logic Level

0.4VA maximum @ 28V AC/DC maximum

Note: Complete explanation of operating range in Supplement section.

Gold over Silver

Power Level or Logic Level

See above for each rating

Note: Gold over silver is available as a custom option. This dual rated option is suitable when two or more identical switches are used in logic and in power circuits within the same application. See Supplement section to find complete explanation of dual rating and operating range.

TERMINALS

01 Solder Lug

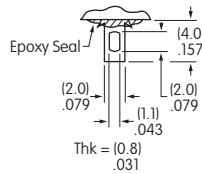

03 .250" (6.35mm) Straight PC

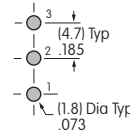
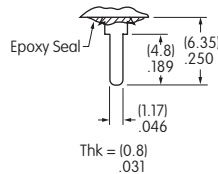

Single Pole

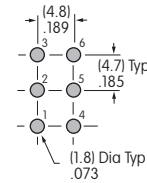

Double Pole

ROCKERS & PADDLES

F AT4150
.450" (11.43mm)
Wide Rocker

Material: Polyamide
Finish: Matte

Colors Available:
A, B, C, E, F, G, H

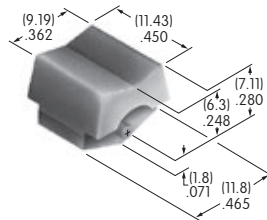

G AT4151
.450" (11.43mm)
Wide Paddle

Material: Polyamide
Finish: Matte

Colors Available:
A, B, C, E, F, G, H

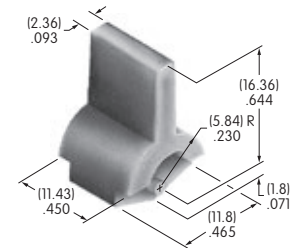

Cap Colors Available:



Black



White



Red



Yellow



Green



Blue



Gray

OPTIONAL SNAP-IN BEZELS & BEZEL COLORS

1 AT2107 Bezel

Material:
Polyamide

Finish:
Matte

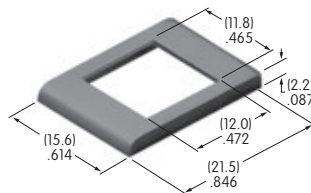

Black



Green



White



Blue



Yellow



Gray

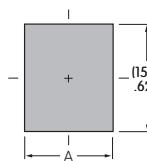

| | Single Pole | Double Pole |
|---|-------------------|-------------------|
| A | (12.5)mm .492" | (13.1)mm .516" |

3 AT212 Bezel
for AT617 LED

Material:
Polycarbonate

Finish:
Semi-glossy

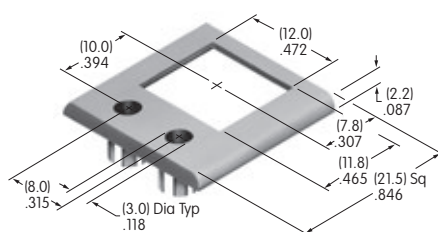

Black

LED colors and specifications are on the following page.

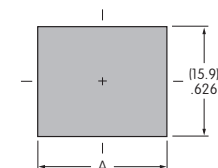

| | Single Pole | Double Pole |
|---|-------------------|-------------------|
| A | (18.4)mm .724" | (18.7)mm .736" |

Bezel Assembly

1. Pry out tab on bezel to a 45° angle.
2. Insert switch frame under tab and snap on bezel.
3. Push tab back into place.
4. Snap assembled bezel and switch into panel.

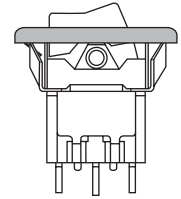
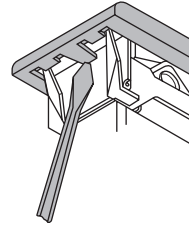
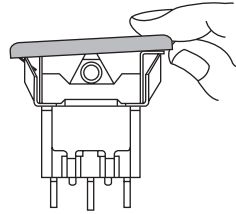
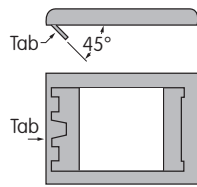

LED COLORS & SPECIFICATIONS

AT617 LED

For Bezel AT212
with 2 Round LEDs

Note: Lead lengths may differ from manufacturing lot to lot. The longer lead is the anode (+).

Bezel Orientation on Switch

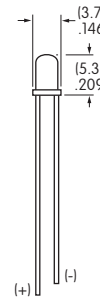
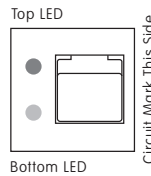

AT617 LED



Color

C Red

E Yellow

F Green

Maximum Forward Current

I_{FM}

30mA

30mA

30mA

Typical Forward Current

I_F

20mA

20mA

20mA

Forward Voltage

V_F

2.1V

2.1V

2.2V

Maximum Reverse Voltage

V_{RM}

5V

5V

5V

Current Reduction Rate Above 25°C

ΔI_F

0.40mA/°C

0.40mA/°C

0.40mA/°C

Ambient Temperature Range (when used with a bezel)

-15° ~ +70°C

The electrical specifications shown are determined at a basic temperature of 25°C.
The LED circuit is independent of switch operation. LED is colored in OFF state.

If the source voltage is greater than the rated voltage of the LED, a ballast resistor must be connected in series with the lamp. The ballast resistor calculation and more lamp detail are shown in the Supplement section.

LEGENDS

NKK Switches can provide custom legends for caps. Contact factory for more information.

Suggested Printable Area for Cap

Recommended Print Method:

Pad Print

Epoxy based ink is recommended.



AT4150

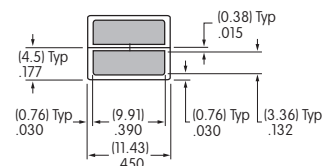

Shaded areas are printable areas.

TYPICAL SWITCH DIMENSIONS

Single Pole

Snap-in Frame • Solder Lug

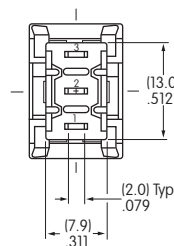
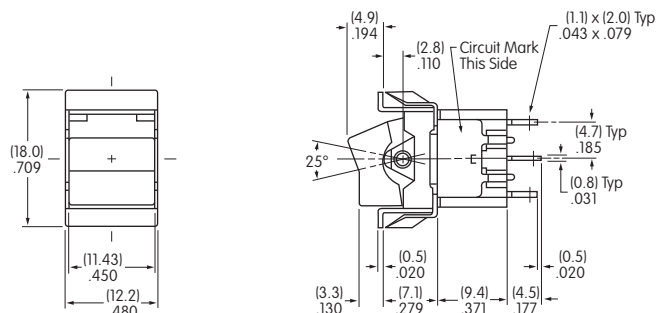

MN12TJW01-FC

Double Pole

Snap-in Frame • Solder Lug

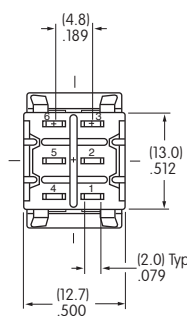
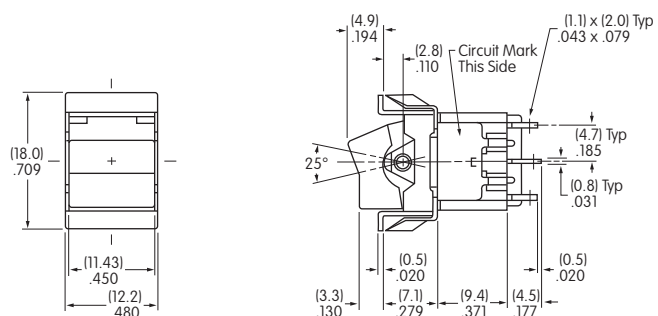

MN22TJW01-FC

Single Pole

Snap-in Frame • Solder Lug

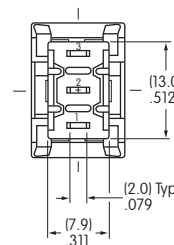
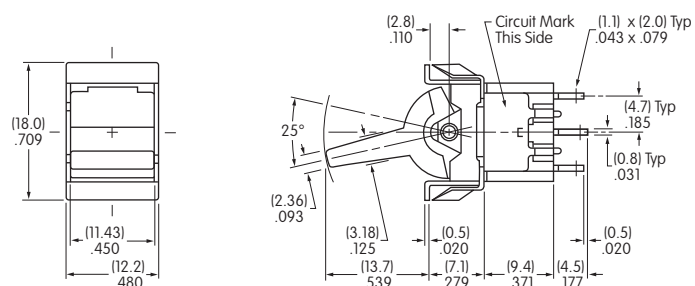

MN12TJW01-GC

Toggles

B Rockers

Pushbuttons

Illuminated PB

Programmable

Keylocks

Rotaries

Slides

Tactiles

Tilt

Touch

Indicators

Accessories

Supplement

TYPICAL SWITCH DIMENSIONS

Snap-in Frame • Solder Lug

Double Pole

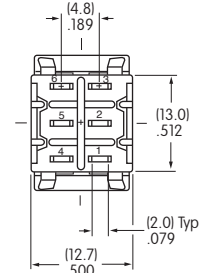
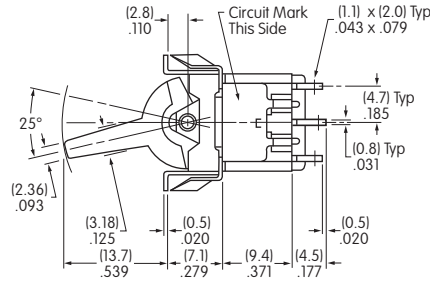
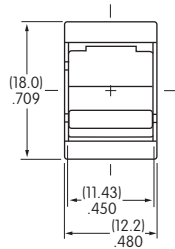

MN22TJW01-GC

Snap-in Frame • AT2107 Bezel • Solder Lug

Single & Double Pole

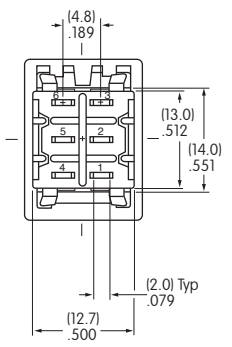
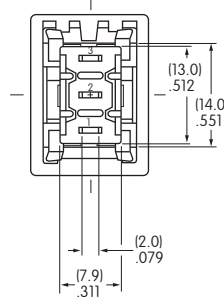
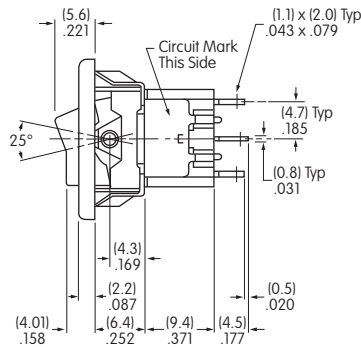
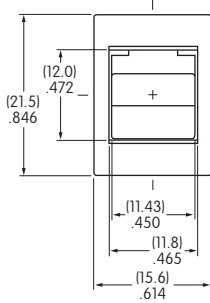

MN12TJW01-FC-1A

Snap-in Frame • AT212 Bezel • Solder Lug

Single Pole

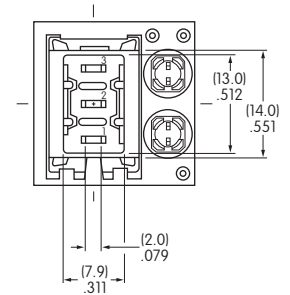
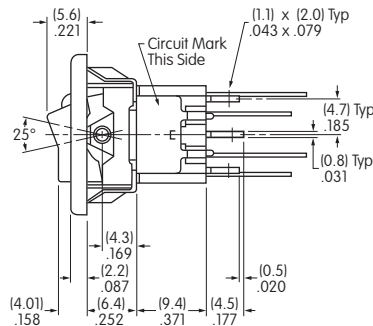
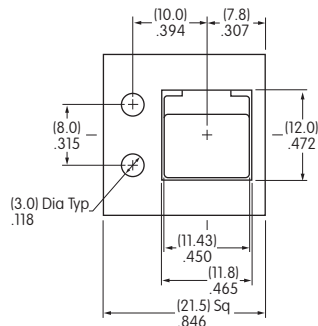

MN12TJW01-FC-3A-CF

TYPICAL SWITCH

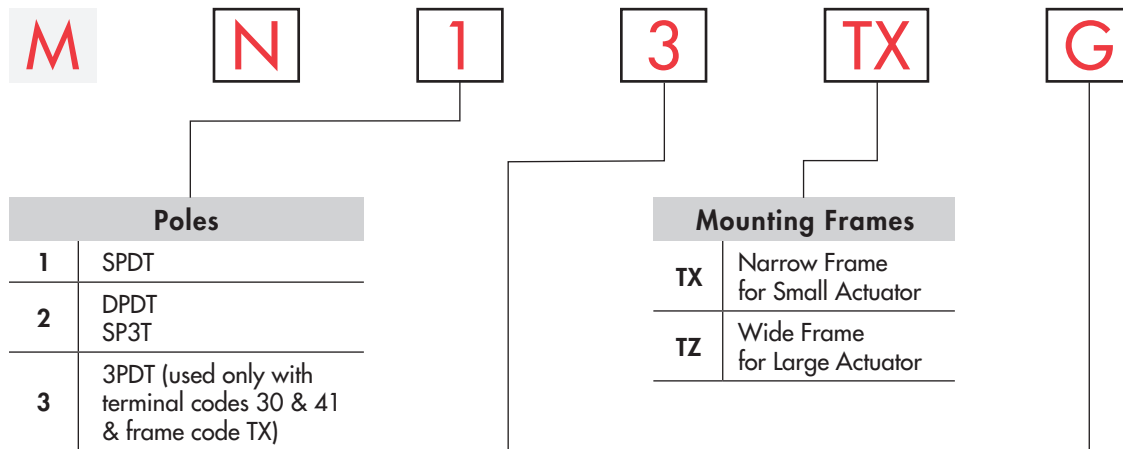

| Poles | |
|-------|--|
| 1 | SPDT |
| 2 | DPDT SP3T |
| 3 | 3PDT (used only with terminal codes 30 & 41 & frame code TX) |

| Mounting Frames | |
|-----------------|---------------------------------|
| TX | Narrow Frame for Small Actuator |
| TZ | Wide Frame for Large Actuator |

| Circuits | | | |
|----------|------|------|------|
| 2 | ON | NONE | ON |
| 3 | ON | OFF | ON |
| 5 | ON | NONE | (ON) |
| 8 | (ON) | OFF | (ON) |
| 9 | ON | OFF | (ON) |
| *4 | ON | ON | ON |

NONE = No Position
() = Momentary
*3-ON circuits

| Contact Materials & Ratings | |
|-----------------------------|--|
| W | Silver; Rated 6A @ 125V AC & 3A @ 250V AC |
| G | Gold; Rated 0.4VA max @ 28V AC/DC max |

DESCRIPTION FOR TYPICAL ORDERING EXAMPLE

MN13TXG41-DC

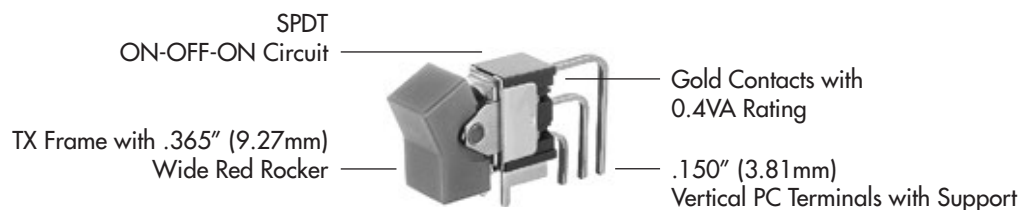

ORDERING EXAMPLE

41

Terminals For TX & TZ Frames

Straight PC with Bracket (1-2 Pole only)

| | |
|-----------|--|
| 13 | .250" (6.35mm) Straight PC with .465" (11.8mm) Bracket |
|-----------|--|

Terminals For TX Frame Only

Right Angle PC with Support (1-3 Pole only)

| | |
|-----------|-------------------------------|
| 30 | .150" (3.81mm) Right Angle PC |
|-----------|-------------------------------|

Vertical PC with Support (1-3 Pole)

| | |
|-----------|----------------------------|
| 41 | .150" (3.81mm) Vertical PC |
|-----------|----------------------------|

D

C

Rockers & Paddles

Small Actuators (TX Frame)

| | |
|----------|-----------------------------|
| D | .365" (9.27mm) Wide Rocker |
| E | .365" (9.27mm) Wide Paddle |
| F | .450" (11.43mm) Wide Rocker |
| G | .450" (11.43mm) Wide Paddle |

Large Actuators (TZ Frame)

| | |
|----------|-----------------------------|
| J | .595" (15.11mm) Wide Rocker |
| H | .595" (15.11mm) Wide Paddle |

Rocker & Paddle Colors

| | |
|----------|--------|
| A | Black |
| B | White |
| C | Red |
| E | Yellow |
| F | Green |
| G | Blue |
| H | Gray |

- Supplement
- Accessories
- Indicators
- Touch
- Tilt
- Tactiles
- Slides
- Rotaries
- Keylocks
- Programmable
- Illuminated PB
- Pushbuttons
- Rockers
- Toggles

Toggle

Rockers

Pushbuttons

Illuminated PB

Programmable

Keylocks

Rotaries

Slides

Tactiles

Tilt

Touch

Indicators

Accessories

Supplement

POLES & CIRCUITS

| Pole | Model | Rocker Position | | | Connected Terminals | | | Throw & Schematics |
|------|--|-----------------------------------|-----------------------------------|----------------------------------|---------------------|--------|----------------|---|
| | | Down | Center | Up | Down | Center | Up | |
| | | | | | | | | Note: Terminal numbers are not actually on the switch. * Reverse circuits available for vertical mount SP & DP upon request. |
| | | NONE = No Position () =Momentary | | | | | | |
| SP | MN12 MN13 *MN15 MN18 *MN19 | ON ON ON (ON) ON | NONE OFF NONE OFF OFF | ON ON (ON) (ON) (ON) | | OPEN | 2-1 | SPDT |
| DP | MN22 MN23 *MN25 MN28 *MN29 | ON ON ON (ON) ON | NONE OFF NONE OFF OFF | ON ON (ON) (ON) (ON) | 2-3 5-6 | OPEN | 2-1 5-4 | DPDT |
| 3P | MN32 MN33 *MN35 MN38 *MN39 | ON ON ON (ON) ON | NONE OFF NONE OFF OFF | ON ON (ON) (ON) (ON) | 2-3 5-6 8-9 | OPEN | 2-1 5-4 8-7 | 3PDT |

For 3 Throw (3-On)

Connected Terminals & Schematics

| Pole | Model | Down | Center | Up | Down | Center | Up |
|------|----------------------|------------------|----------------|--------------------|------|--------|----|
| SP | MN24 MN26 MN27 | ON (ON) ON | ON ON ON | ON (ON) (ON) | | | |

The SP3T model utilizes a double pole base.

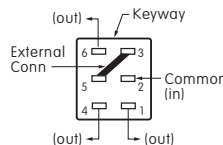

External connection must be made during field installation.

MOUNTING FRAMES

TX Narrow Mounting Frame for Small Actuators with Straight PC Terminals (codes 13, 15, 17, 23, 25, & 26) or with Angle PC Terminals (codes 30 & 41)

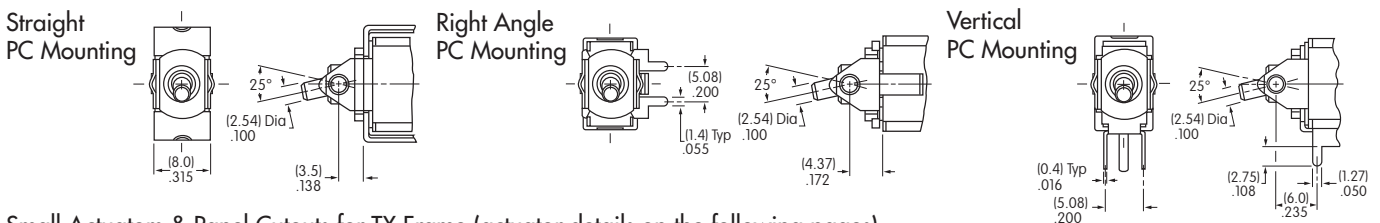

Small Actuators & Panel Cutouts for TX Frame (actuator details on the following pages)

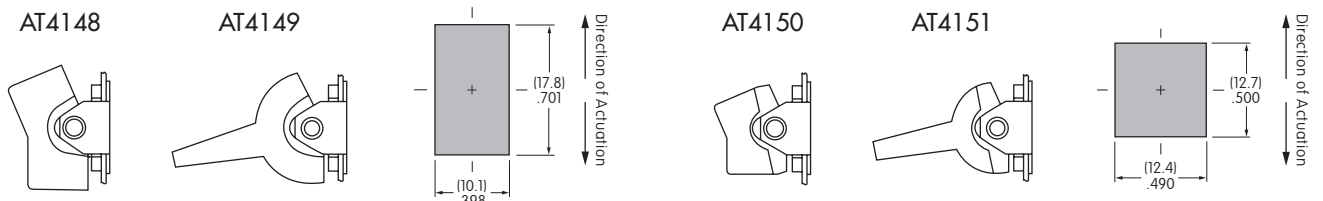

MOUNTING FRAMES

TZ Wide Mounting Frame for Large Actuators with Straight PC Terminals (codes 13, 15, 17, 23, 25, & 26)

Large Actuators & Panel Cutouts for TZ Frame (actuator details on the following pages)

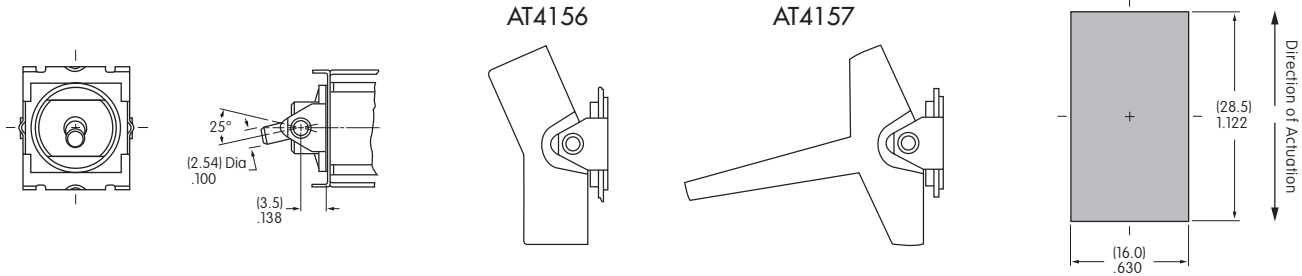

CONTACT MATERIALS & RATINGS

W Silver Power Level

- MN12, MN22: 6A @ 125V AC, 3A @ 250V AC, 4A @ 30V DC
- MN13, MN15, MN18, MN19: 6A @ 125V AC, 3A @ 250V AC, 3A @ 30V DC
- MN23, MN25: 6A @ 125V AC, 3A @ 250V AC, 3A @ 30V DC
- MN28, MN29: 4A @ 125V AC, 3A @ 250V AC, 3A @ 30V DC
- MN24: 3A @ 125V AC, 2A @ 250V AC, 2A @ 30V DC
- MN32: 4A @ 125V AC, 2A @ 250V AC, 3A @ 30V DC
- MN33, MN35, MN38, MN39: 4A @ 125V AC, 2A @ 250V AC, 2A @ 30V AC

G Gold

Logic Level

0.4VA maximum @ 28V AC/DC maximum

Note: Complete explanation of operating range in Supplement section.

Gold over Silver

Power Level or Logic Level

See above for ratings

Note: Gold over silver is available as a custom option. This dual rated option is suitable when two or more identical switches are used in logic and in power circuits within the same application. See Supplement section to find complete explanation of dual rating and operating range.

TERMINALS

For TX and TZ 1-2 Pole Straight PC Mount with Bracket

13 .250" (6.35mm) Terminal with .465" (11.8mm) Bracket

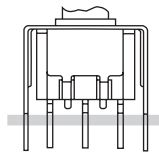

PCB footprints are on the following Typical Switch Dimension pages.

For TX 1-3 Pole Right Angle PC Mount

30 .150" (3.81mm) Right Angle PC

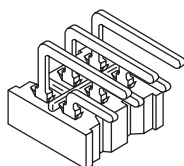

For TX 1-4 Pole Vertical PC Mount

41 .150" (3.81mm) Vertical PC

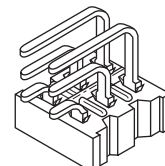

Toggles
Rockers
Pushbuttons
Illuminated PB
Programmable
Keylocks
Rotaries
Slides
Tactiles
Tilt
Touch
Indicators
Accessories
Supplement

ROCKERS & PADDLES FOR TX MOUNTING FRAMES

D AT4148 .365" (9.27mm)
Wide Rocker

Material: Polyamide
Finish: Matte

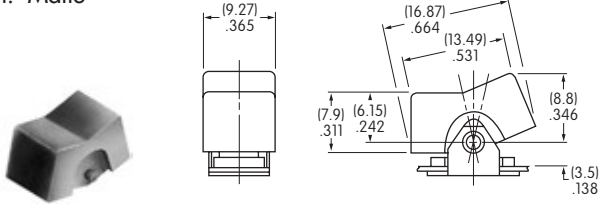

E AT4149 .365" (9.27mm)
Wide Paddle

Material: Polyamide
Finish: Matte

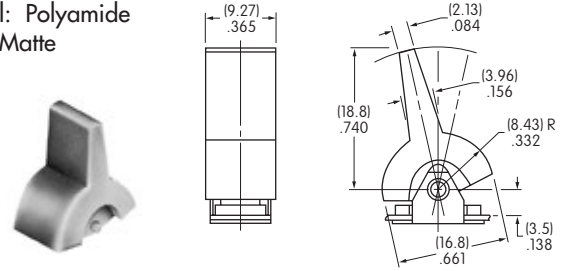

F AT4150 .450" (11.43mm)
Wide Rocker

Material: Polyamide
Finish: Matte

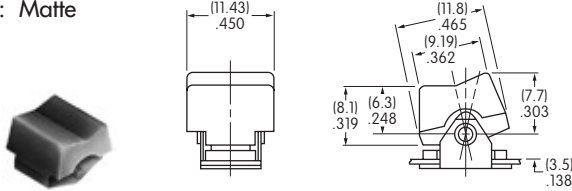

G AT4151 .450" (11.43mm)
Wide Paddle

Material: Polyamide
Finish: Matte

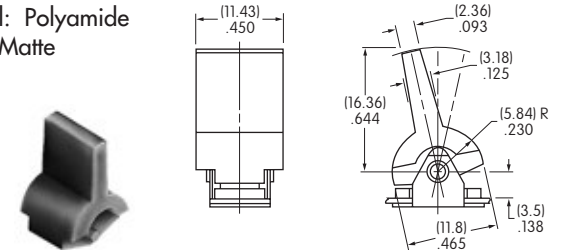

Cap Colors Available:



Black



White



Red



Yellow



Green



Blue



Gray

ROCKERS & PADDLES FOR TZ MOUNTING FRAMES

J AT4156 .595" (15.11mm)
Wide Rocker

Material: Polyamide
Finish: Matte

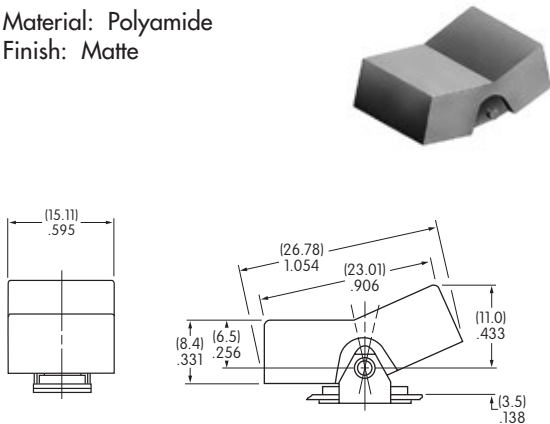

H AT4157 .595" (15.11mm)
Wide Paddle

Material: Polyamide
Finish: Matte

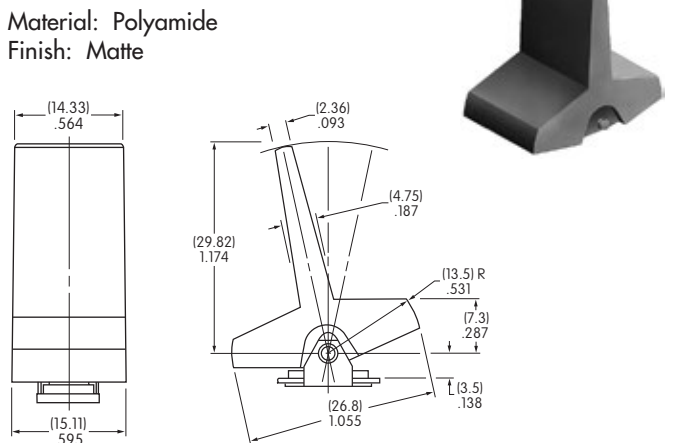

Cap Colors Available:



Black



White



Red



Yellow



Green



Blue



Gray

OPTIONAL SNAP-IN PANEL FRAMES

Used with AT4148 Rocker and AT4149 Paddle

AT064-1

Accommodates .047" ~ .090"
(1.2 ~ 2.3mm) panel thickness

Material: Polyamide
Finish: Matte
Color: Black

Mounted separately from switches

Cutout Tolerances:

Dimension A:
.797" ~ .803" (20.24 ~ 20.4mm)

Dimension B:
.495" ~ .505" (12.57 ~ 12.83mm)



AT064-2

Accommodates .062" ~ .125"
(1.57 ~ 3.18mm) panel thickness

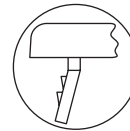
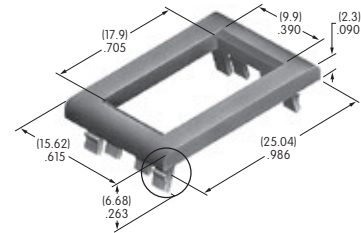

AT064-1 Enlarged Detail

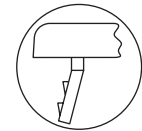

Used with AT4150 Rocker and AT4151 Paddle

AT065-1

Accommodates .047" ~ .090"
(1.2 ~ 2.3mm) panel thickness

Material: Polyamide
Finish: Matte
Color: Black

Mounted separately from switches

Cutout Tolerances:

Dimension A:
.595" ~ .605" (15.11 ~ 15.37mm)

Dimension B:
.495" ~ .500" (12.57 ~ 12.7mm)



AT065-2

Accommodates .062" ~ .125"
(1.57 ~ 3.18mm) panel thickness

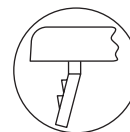
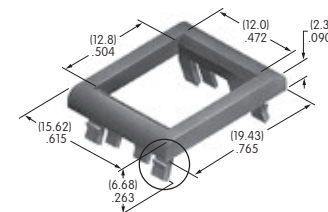

AT065-1 Enlarged Detail

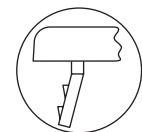

AT065-2 Enlarged Detail

Toggles

B Rockers

Pushbuttons

Illuminated PB

Programmable

Keylocks

Rotaries

Slides

Tactiles

Tilt

Touch

Indicators

Accessories

Supplement

TYPICAL SWITCH DIMENSIONS

Straight PC • Bracket

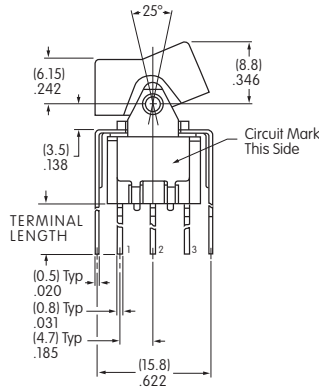

Single Pole

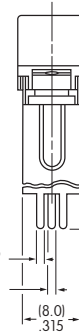

Double Pole

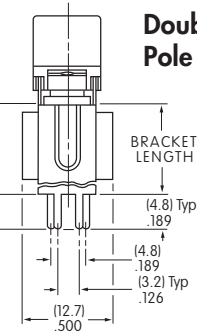

MN12TXG13-DC

| Terminal Code: | Terminal Length: | Bracket Length: |
|----------------|------------------|-----------------|
| 13 | .250" (6.35mm) | .465" (11.8mm) |

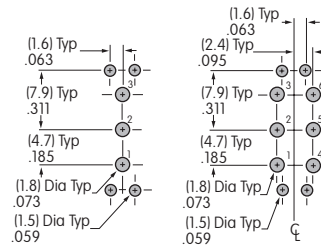

.150" (3.81mm) Right Angle PC

Single Pole

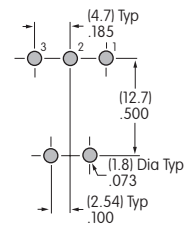
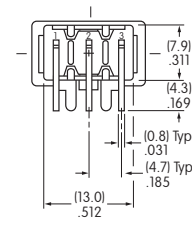
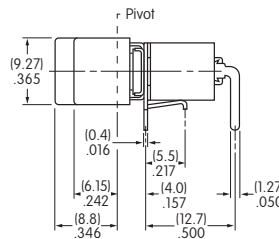
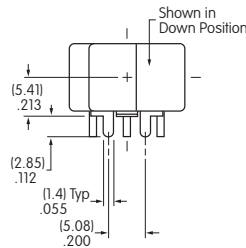

MN12TXG30-DC

.150" (3.81mm) Right Angle PC

Double Pole

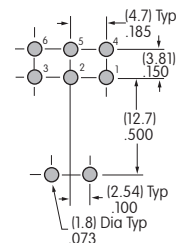
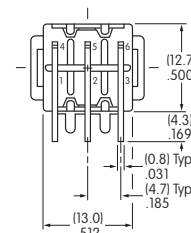
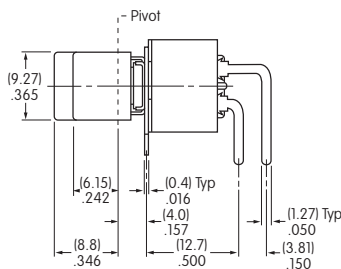
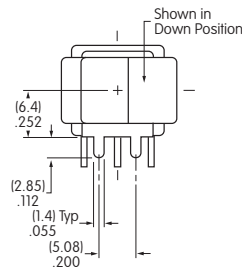

MN22TXG30-DC

TYPICAL SWITCH DIMENSIONS

Three Pole

.150" (3.81mm) Right Angle PC

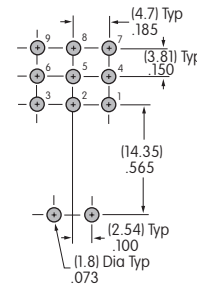
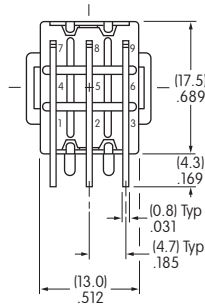
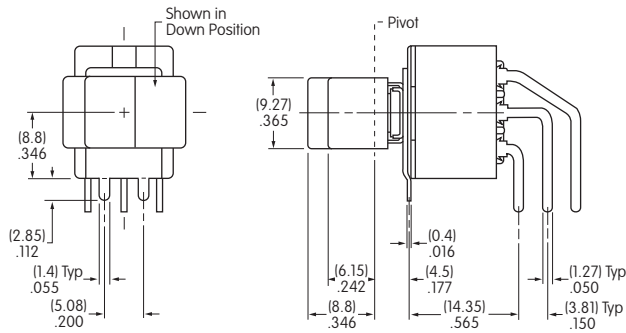

MN32TXG30-DC

Single Pole

.150" (3.81mm) Vertical PC

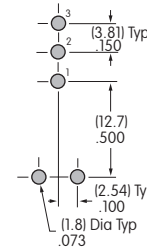
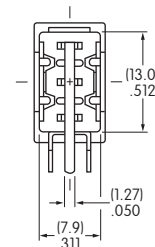
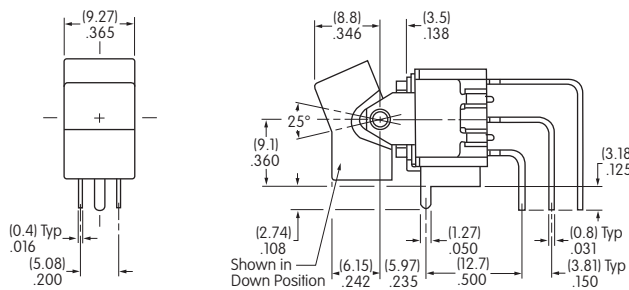

MN12TXG41-DC

Double Pole

.150" (3.81mm) Vertical PC

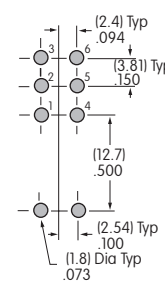
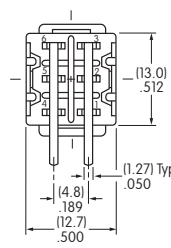
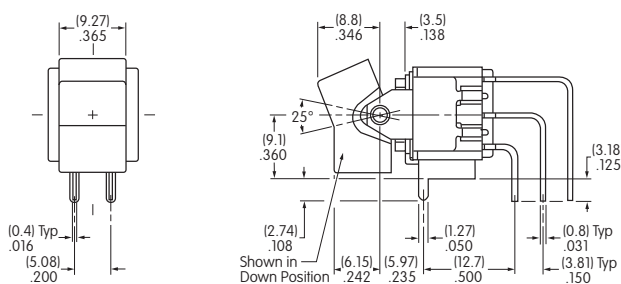

MN22TXG41-DC

Three Pole

.150" (3.81mm) Vertical PC

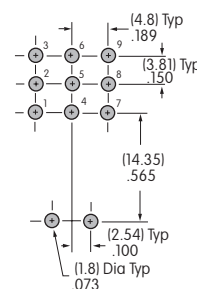
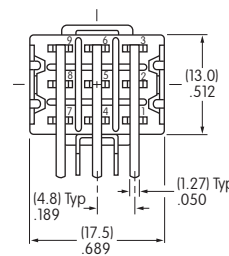
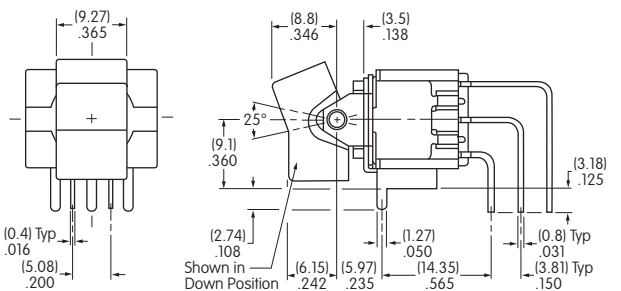

MN32TXG41-DC

TYPICAL SWITCH DIMENSIONS

Straight PC • Bracket

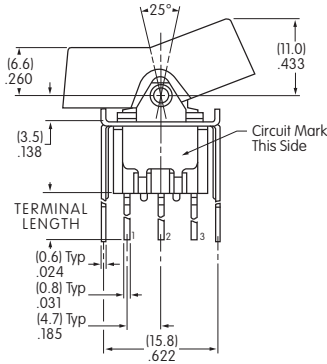

Single Pole

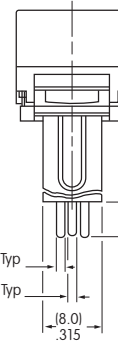

Double Pole

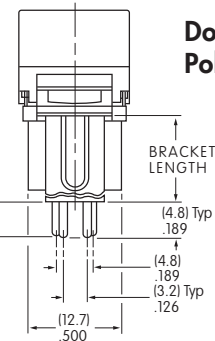

MN12TZG13-JC

| Terminal Code: | Terminal Length: | Bracket Length: |
|----------------|------------------|-----------------|
| 13 | .250" (6.35mm) | .465" (11.8mm) |

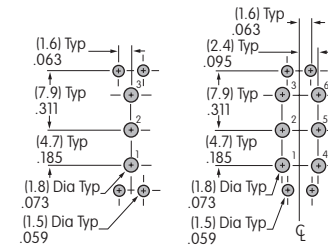

LEGENDS

NKK Switches can provide custom legends for caps. Contact factory for more information.

Suggested Printable Area for Cap

AT4148



AT4150



AT4156

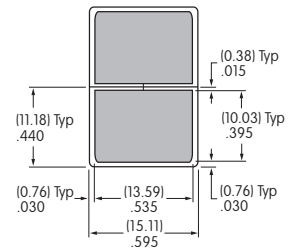
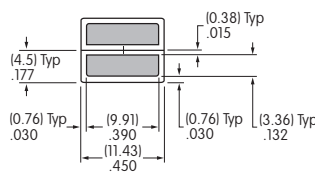
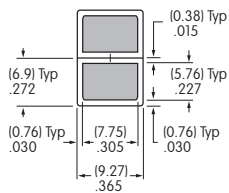

Shaded areas are printable areas.

Recommended Print Method: Pad Print. Epoxy based ink is recommended.

TYPICAL SWITCH ORDERING EXAMPLE

M **N** **1** **2** **TN** **W** **01** — **D** **C**

| Poles | |
|-------|--------------|
| 1 | SPDT |
| 2 | DPDT SP3T |
| 3 | 3PDT |

| Mounting Frame | |
|----------------|--------------------------------|
| TN | .272" (6.9mm) Wide Flat Frame |
| TY | .504" (12.8mm) Wide Flat Frame |

| Terminals | |
|-----------|----------------------------|
| 01 | Solder Lug |
| 03 | .250" (6.35mm) Straight PC |

| Circuits | | | |
|----------|------|------|------|
| 2 | ON | NONE | ON |
| 3 | ON | OFF | ON |
| 8 | (ON) | OFF | (ON) |
| *4 | ON | ON | ON |

NONE = No Position
() = Momentary
*3-ON circuits

| Contact Materials & Ratings | |
|-----------------------------|---|
| W | Silver; Rated 6A @ 125V AC & 3A @ 250V AC |
| G | Gold; Rated 0.4VA max @ 28V AC/DC max |

| Rockers & Paddles | |
|----------------------------|-----------------------------|
| Small Actuators (TN Frame) | |
| D | .365" (9.27mm) Wide Rocker |
| E | .365" (9.27mm) Wide Paddle |
| F | .450" (11.43mm) Wide Rocker |
| G | .450" (11.43mm) Wide Paddle |
| Large Actuators (TY Frame) | |
| J | .595" (15.11mm) Wide Rocker |
| H | .595" (15.11mm) Wide Paddle |

| Rocker & Paddle Colors | |
|------------------------|--------|
| A | Black |
| B | White |
| C | Red |
| E | Yellow |
| F | Green |
| G | Blue |
| H | Gray |

DESCRIPTION FOR TYPICAL ORDERING EXAMPLE

MN12TNW01-DC

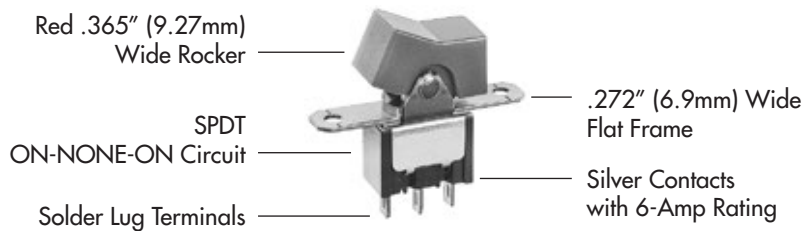

POLES & CIRCUITS

| Pole | Model | Rocker Position | | | Connected Terminals | | | Throw & Schematics |
|------|----------------------|------------------------------------|--------------------|------------------|---------------------|--------|----------------|--|
| | | Down | Center | Up | Down | Center | Up | |
| | | NONE = No Position () = Momentary | | | | | | |
| | | | | | | | | Note: Terminal numbers are not actually on the switch. |
| SP | MN12 MN13 MN18 | ON ON (ON) | NONE OFF OFF | ON ON (ON) | 2-3 | OPEN | 2-1 | SPDT |
| DP | MN22 MN23 MN28 | ON ON (ON) | NONE OFF OFF | ON ON (ON) | 2-3 5-6 | OPEN | 2-1 5-4 | DPDT |
| 3P | MN32 MN33 MN38 | ON ON (ON) | NONE OFF OFF | ON ON (ON) | 2-3 5-6 8-9 | OPEN | 2-1 5-4 8-7 | 3PDT |

For 3 Throw (3-On)

Connected Terminals & Schematics

| Pole | Model | Down | Center | Up | Down | Center | Up |
|------|-------|------|--------|----|---------|---------|---------|
| SP | MN24 | ON | ON | ON | 2-3 5-6 | 2-3 5-4 | 2-1 5-4 |

The SP3T model utilizes a double pole base.

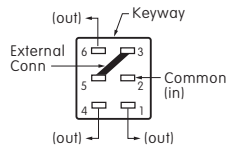

External connection must be made during field installation.

MOUNTING FRAMES

TN .272" (6.9mm) Wide Flat Frame

Small Actuators & Panel Cutouts for TN Frame
(actuator details on the following pages)

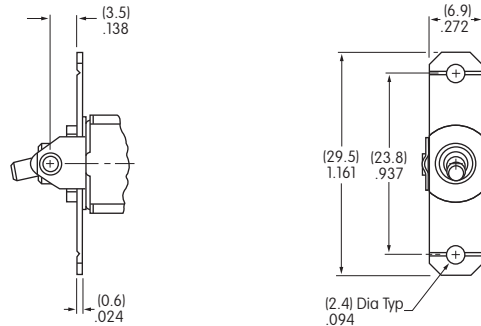

AT4148

AT4149

AT4150

AT4151

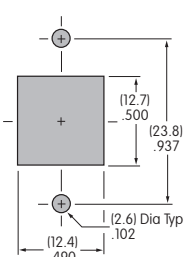
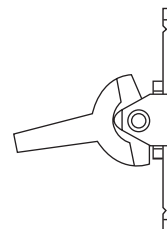
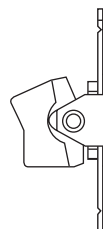
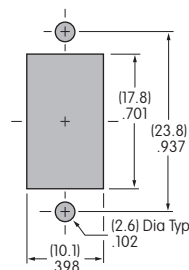
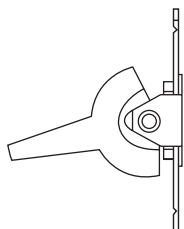
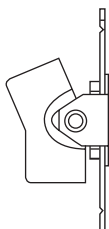

MOUNTING FRAMES

TY

.504" (12.8mm) Wide Flat Frame

Large Actuators & Panel Cutout for TY Frame
(actuator details on the following pages)

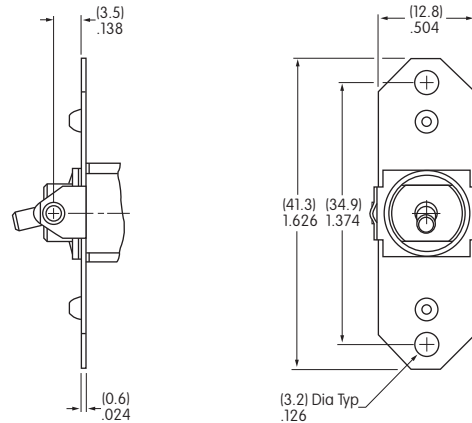

AT4156

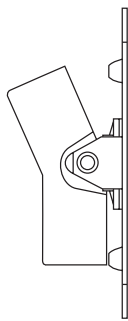

AT4157

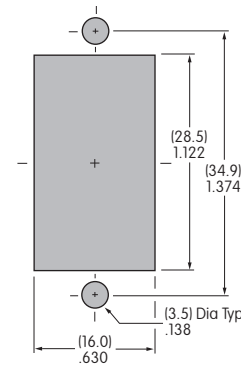
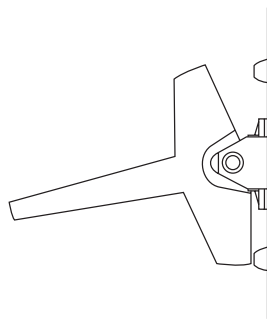

CONTACT MATERIALS & RATINGS

W

Silver Power Level

- MN12, MN22:** 6A @ 125V AC, 3A @ 250V AC, 4A @ 30V DC
- MN13, MN18, MN23:** 6A @ 125V AC, 3A @ 250V AC, 3A @ 30V DC
- MN28:** 4A @ 125V AC, 3A @ 250V AC, 3A @ 30V DC
- MN32:** 4A @ 125V AC, 2A @ 250V AC, 3A @ 30V DC
- MN33, MN38:** 4A @ 125V AC, 2A @ 250V AC, 2A @ 30V DC
- MN24:** 3A @ 125V AC, 2A @ 250V AC, 2A @ 30V DC

G

Gold

Logic Level

0.4VA maximum @ 28V AC/DC maximum

Note: Complete explanation of operating range in Supplement section.

Gold over Silver

**Power Level
or Logic Level**

See above for each rating

Note: Gold over silver is available as a custom option. This dual rated option is suitable when two or more identical switches are used in logic and in power circuits within the same application. See Supplement section to find complete explanation of dual rating and operating range.

TERMINALS

01 Solder Lug

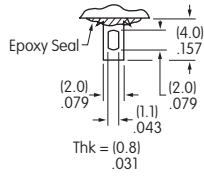

03 .250" (6.35mm) Straight PC

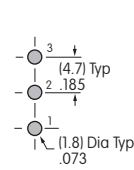
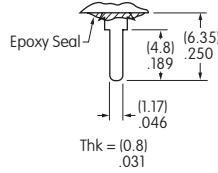

Single Pole

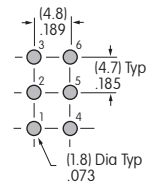

Double Pole

ROCKERS & PADDLES

For TN Frame

D AT4148 .365" (9.27mm) Wide Rocker



Material:
Polyamide
Finish: Matte

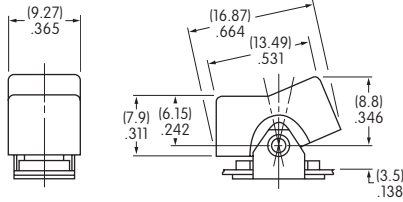

E AT4149 .365" (9.27mm) Wide Paddle



Material:
Polyamide
Finish: Matte

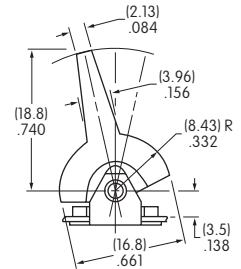

F AT4150 .450" (11.43mm) Wide Rocker



Material:
Polyamide
Finish: Matte

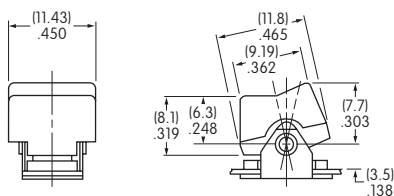

G AT4151 .450" (11.43mm) Wide Paddle



Material:
Polyamide
Finish: Matte

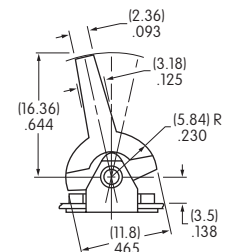

ROCKERS & PADDLES

For TY Frame

J AT4156 .595" (15.11mm)
Wide Rocker

Material:
Polyamide
Finish: Matte

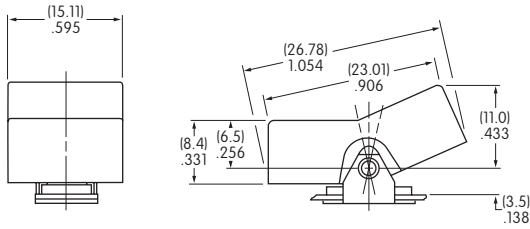
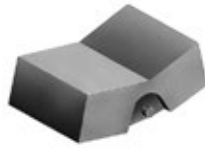

H AT4157 .595" (15.11mm)
Wide Paddle

Material:
Polyamide
Finish: Matte

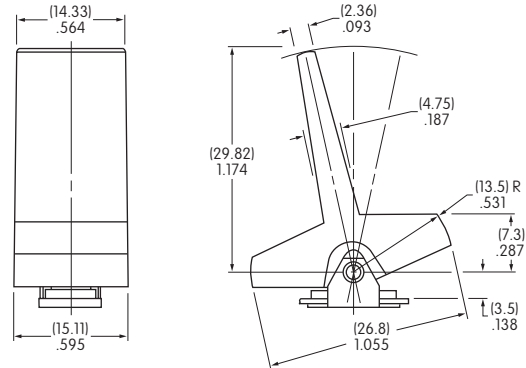

Cap Colors Available:

A Black

B White

C Red

E Yellow

F Green

G Blue

H Gray

TYPICAL SWITCH DIMENSIONS

Single Pole

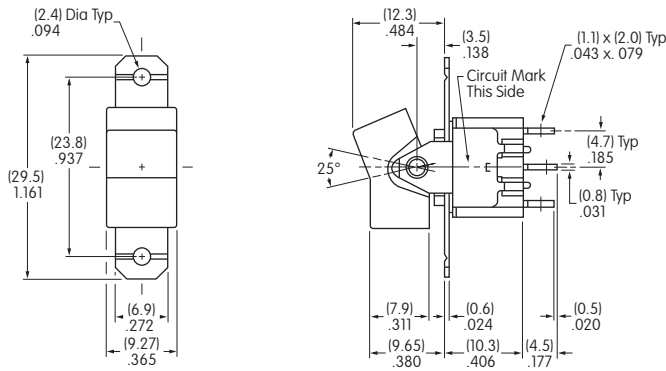

TN Frame • Solder Lug

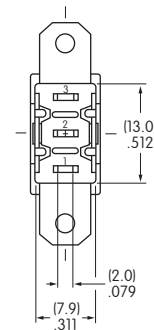

MN12TNW01-DC

Double Pole

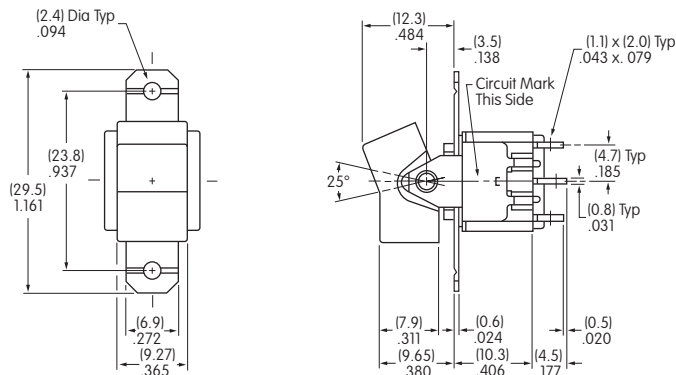

TN Frame • Solder Lug

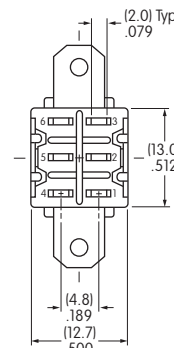

MN22TNW01-DC

TYPICAL SWITCH DIMENSIONS

TN Frame • Solder Lug

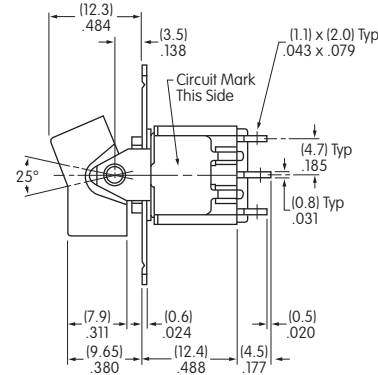
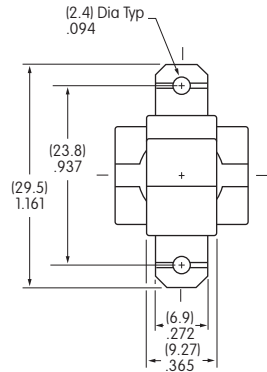

Three Pole

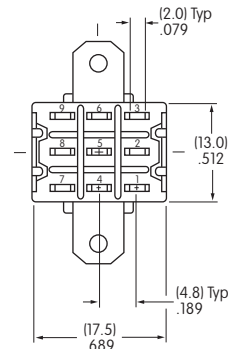

MN32TNW01-DC

TY Frame • Solder Lug

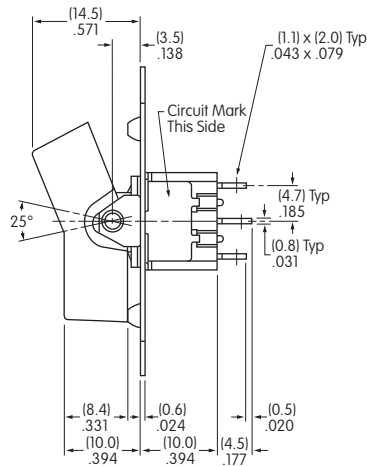
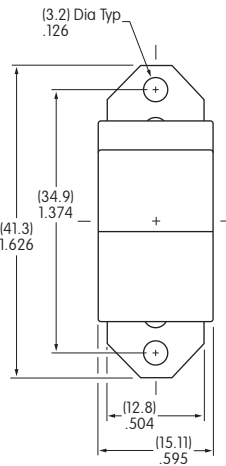

Single Pole

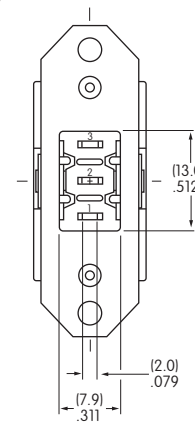

Double Pole

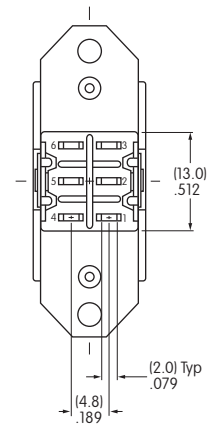

MN12TYW01-JC

Double pole has barrier between terminals.

TY Frame • Solder Lug

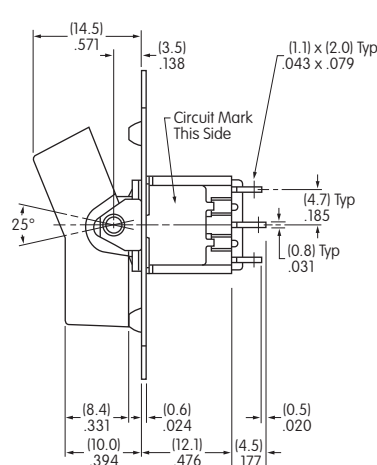
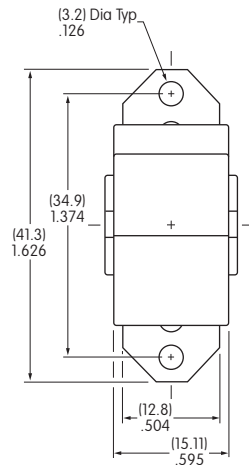

Three Pole

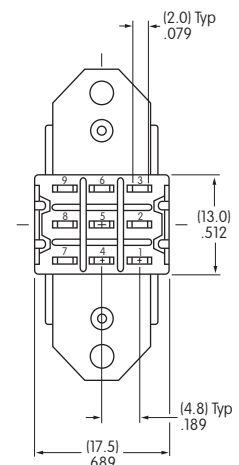

MN32TYW01-JC

LEGENDS

NKK Switches can provide custom legends for caps. Contact factory for more information.

Suggested Printable Area for Caps

AT4148

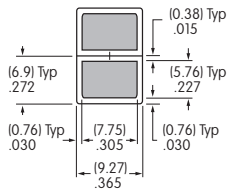

AT4150

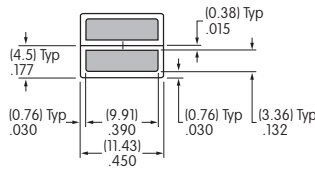

AT4156

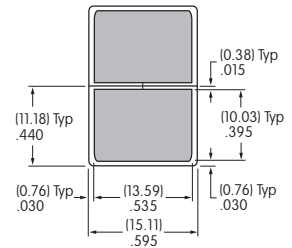

Shaded areas are printable areas.

Recommended Print Method:

Pad Print

Epoxy based ink is recommended.

- Toggles
- B** Rockers
- Pushbuttons
- Illuminated PB
- Programmable
- Keylocks
- Rotaries
- Slides
- Tactiles
- Tilt
- Touch
- Indicators
- Accessories
- Supplement