

## A General Specifications

### Electrical Capacity (Resistive Load)

- Power Level (silver):** 6A @ 125V AC & 3A @ 250V AC  
4A @ 30V DC for On-None-On; 3A @ 30V DC for all other circuits
- Logic Level (gold):** 0.4VA maximum @ 28V AC/DC maximum (Applicable Range 0.1mA ~ 0.1A @ 20mV ~ 28V)

### Other Ratings

- Contact Resistance:** 10 milliohms maximum for silver; 20 milliohms maximum for gold
- Insulation Resistance:** 1,000 megohms minimum @ 500V DC
- Dielectric Strength:** 1,000V AC minimum between contacts for 1 minute minimum;  
1,500V AC minimum between contacts and case for 1 minute minimum
- Mechanical Life:** 50,000 operations minimum
- Electrical Life:** 50,000 operations minimum for silver at 3A @ 250V AC; 25,000 operations minimum for silver at 6A @ 125V AC; 50,000 operations minimum for gold
- Angle of Throw:** 25°

### Environmental Data

- Operating Temp Range:** -30°C through +85°C (-22°F through +185°F)
- Sealing:** Waterproofing, achieved with boot at base of lever plus o-rings inside and outside of bushing, meets IP68 of IEC60529 Standards (dust tight and protection against effects of temporary immersion). See further explanation on page A51.

### Processing

- Soldering:** Manual Soldering for Silver: ON-NONE-ON: See Profile B in Supplement section.  
ON-OFF-ON and (ON)-OFF-(ON): See Profile A in Supplement section.  
Manual Soldering for Gold, all circuits: See Profile A in Supplement section.  
Note: Lever must be in OFF (center) position while soldering.

## Distinctive Characteristics

Inner o-ring and external rubber washer seal the switch to achieve IP68 of IEC60529 Standards (dust tight and water protected for temporary immersion).

Waterproof boot at base of toggle further ensures protection against wet environments.

Actual Size

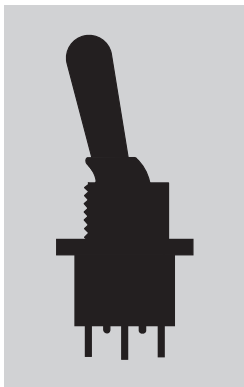

Actuation provides smooth, sturdy tactile feel.

Polished, chrome-plated actuator paired with the waterproof boot not only delivers in terms of sleek design, but also functionality and reliability.

Superb quality and construction design prohibit entry of harmful particles that may otherwise compromise lever operation.

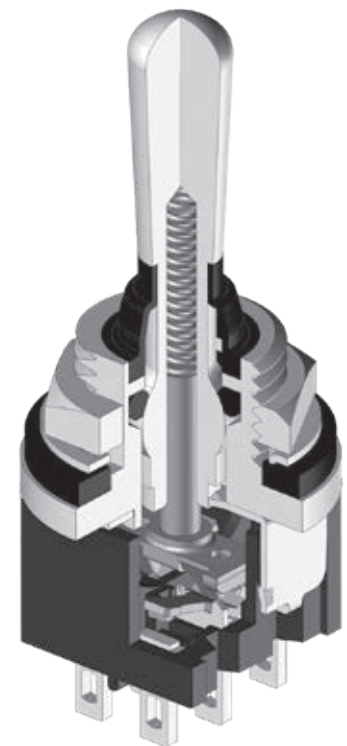

## TYPICAL SWITCH ORDERING EXAMPLE

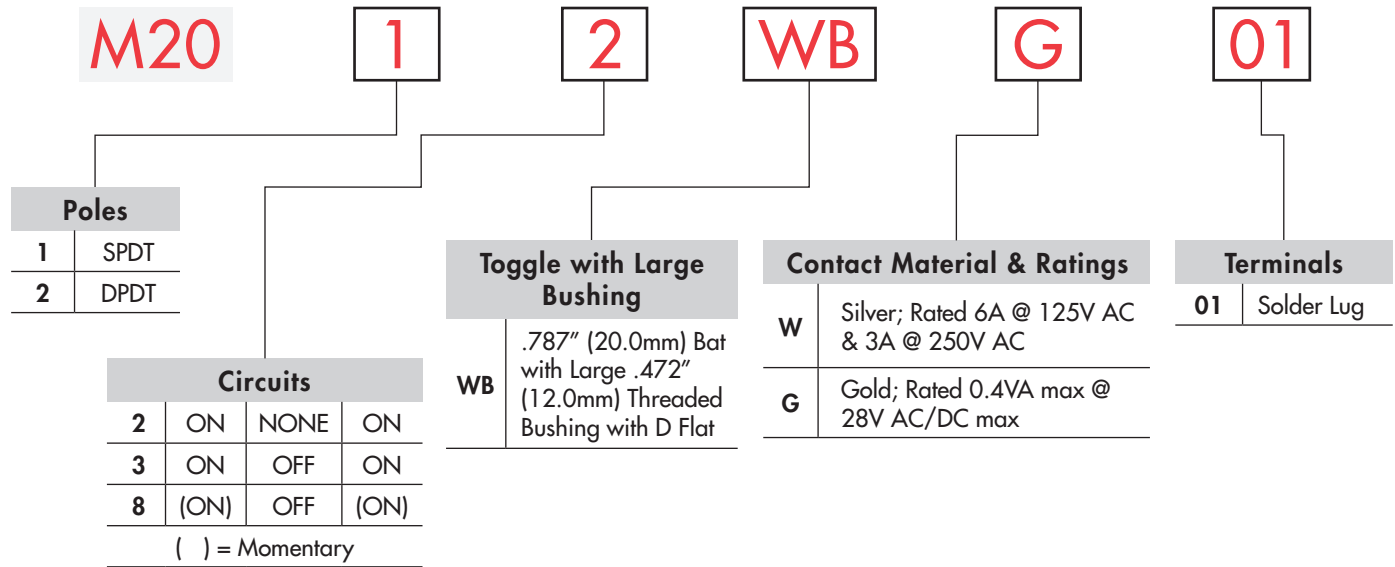

## DESCRIPTION FOR TYPICAL ORDERING EXAMPLE

### M2012WBG01

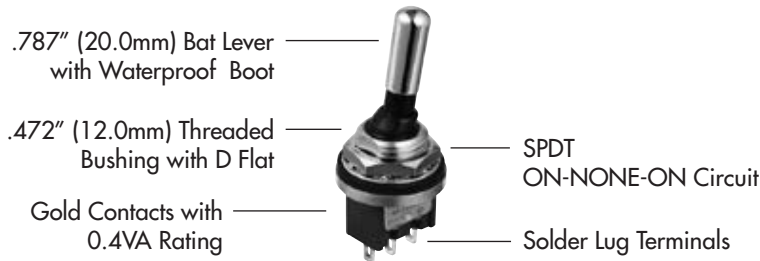

## POLES & CIRCUITS

Pole	Model	Toggle Position ( ) = Momentary			Connected Terminals			Throw & Schematics
		Up	Center	Down	Up	Center	Down	
SP	M2012 M2013 M2018	ON ON (ON)	NONE OFF OFF	ON ON (ON)	Up Flat	Center OPEN	Down 2-1	Note: Terminal numbers are not actually on the switch. 
DP	M2022 M2023 M2028	ON ON (ON)	NONE OFF OFF	ON ON (ON)	Up Flat	Center OPEN	Down 2-1 5-4	

## STANDARD HARDWARE

**AT503M Hex Face Nut**  
Brass/Chrome

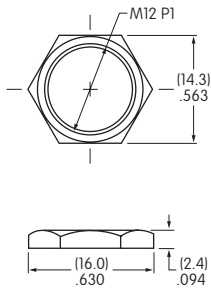

**AT508 Lockwasher**  
Steel with Zinc/Chromate

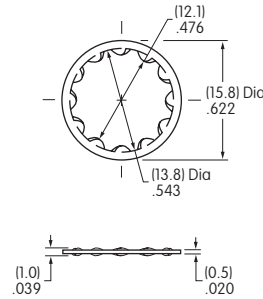

**AT401P O-ring**  
Nitrile Butadiene Rubber

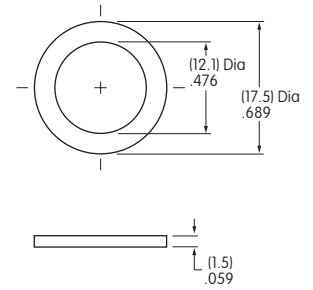

## PANEL CUTOUTS & THICKNESS

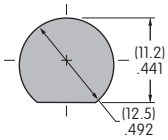

Anti-rotation

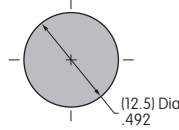

No  
Anti-rotation

Maximum Effective Panel Thickness  
.118" (3.0mm)

## TYPICAL SWITCH DIMENSIONS

**Solder Lug**

**Single Pole**

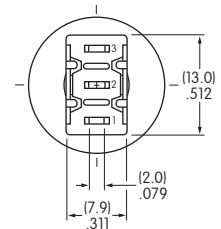
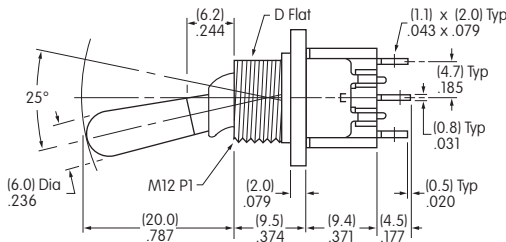
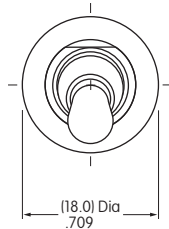

**M2012WBG01**

**Solder Lug**

**Double Pole**

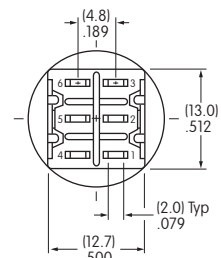
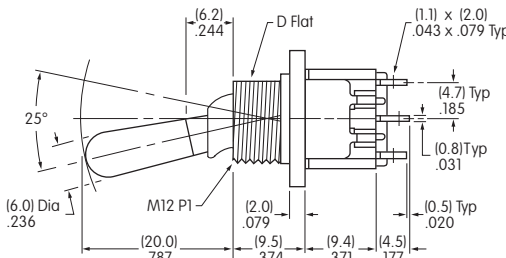
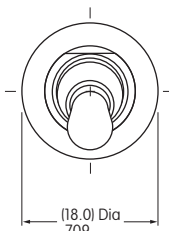

**M2022WBG01**

## APPLICATION CONSIDERATIONS

The Dual Seal Waterproof M Toggle is designed as a panel seal switch, and not to be used under water.

### Material Properties

The material for the waterproof boot is silicone rubber. While silicone rubber has excellent heat, cold and weather resistant properties, it has less durability and oil resistance.

The o-rings are made of nitrile butadiene rubber, which excels in durability and oil and chemical resistance. Its performance is less durable with lower weather and ozone resistant characteristics.

Evaluate the products in regard to your application and intended environment with these properties in mind.

### Waterproof Test Conditions

Waterproofing is measured by submersing the switch 5 centimeters from the water surface (see illustration), and opening and closing 50 times at a frequency of 50 – 60 times per minute. The switch is then submersed 1.5 meters from the surface and left in this position for 30 minutes.

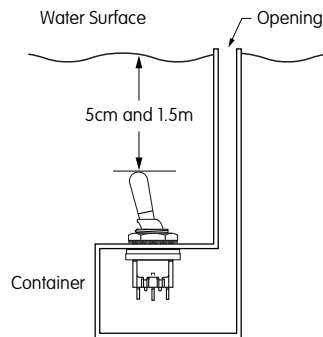

Repeat opening and closing same as previous test. The resulting insulation resistance and voltage capacity are both within the rated values, and water has not entered inside the switch or installation panel.

### Panel Installation

For panel installation, the internal tooth lockwasher is installed above the panel. The external o-ring mounts below the panel.

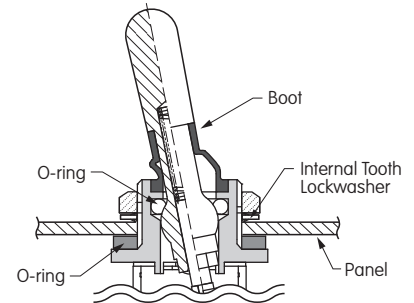

### Applications

- Construction Equipment
- Hospitality and Restaurant
- Transportation
- Medical Equipment
- Machine Tooling
- Marine Equipment \*

\* Salt spray tested as per Mil-STD-810G section 509.5.

A  
Toggles

Rockers

Pushbuttons

Illuminated PB

Programmable

Keylocks

Rotaries

Slides

Tactiles

Tilt

Touch

Indicators

Accessories

Supplement