

DISTINCTIVE CHARACTERISTICS

- Nonilluminated options in 4 or 16 keys, illuminated choices in 12 or 16 keys
- 1.0mm (.039") tail pitch
- Easily integrated into designs: replaces multiple mechanical switches, soldered wires and cable assemblies
- Card insertion into design supports customized legends for nonilluminated models
- Actuating dome offers crisp, tactile feedback to positively indicate circuit transfer
- Illuminated models feature legends on embossed keypads
- Adhesive backing for easy mounting

GENERAL SPECIFICATIONS

Power Level	20mA @ 24V DC
Contact Resistance	500Ω maximum (10mA @ 10V DC)
Insulation Resistance	100 megohms minimum @ 250V DC minimum
Dielectric Strength	250V AC minimum for one minute minimum
Operational Life	1,000,000 operations minimum
Contact Timing	10 milliseconds maximum
Nominal Operating Force	1.0N ~ 6.0N
Stroke:	
Nonilluminated	.016" ~ .039" (0.4mm ~ 1.0mm)
Illuminated with Overlay	.020" ~ .047" (0.5mm ~ 1.2mm)
Operating Temperature Range	-15°C ~ +50°C (+5°F ~ +122°F) illuminated -15°C ~ +55°C (+5°F ~ +131°F) nonilluminated

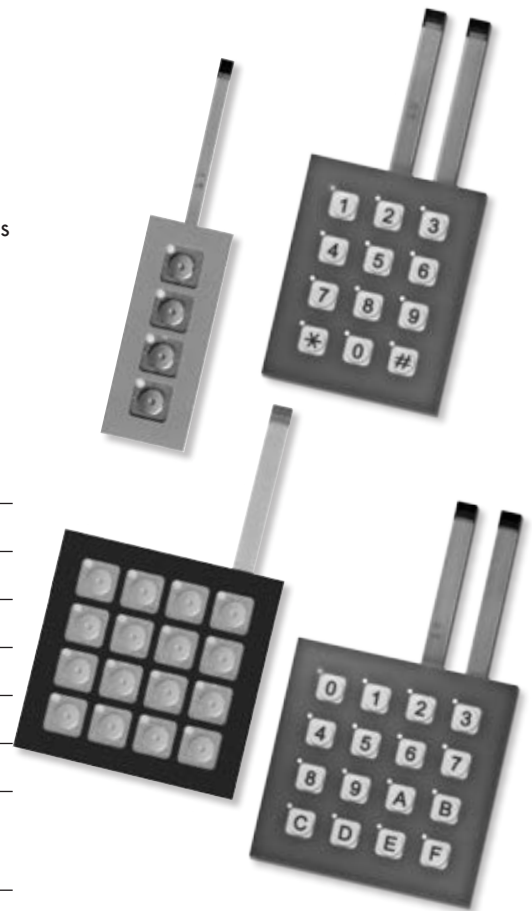

LED SPECIFICATIONS

Single Element LED Color: Amber		Unit	
Forward Voltage (Typical)	V _F	2.1	V
Forward Current (Typical)	I _F	20	mA
Forward Current (Maximum)	I _F	30	mA
* Forward Peak Current (Max)	I _{FM}	195	mA
Reverse Voltage (Maximum)	V _R	5.0	V

The electrical specifications shown are determined at a basic temperature of 25°C. LED is an integral part of the switch. LEDs are not sold separately.

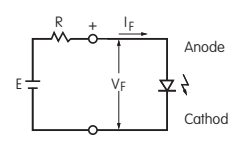

$$R = \frac{E - V_F}{I_F}$$

Where: R = Resistor Value (Ohms)
E = Source Voltage (V)
V_F = Forward Voltage (V)
I_F = Forward Current (A)

LED circuits are isolated and require an external power source. If the source voltage exceeds the rated voltage, a ballast resistor is required.

* Note: Pulse width 0.1 msec maximum with a maximum duty cycle ratio of 1/10

Ordering Information		Description			
Part Number	Illumination	Number of Keys	Surface Sheet Black (D)	Surface Sheet Gray (E)	Overlay
FMBN04BD	Nonilluminated	4	•		
FMBN04BE		4		•	
FMBN16BD		16	•		
FMBN16BE		16		•	
FMBP12BF	Dot Illuminated with Overlay	12			Gray Surface Sheet with Embossed White Keypad and Gray Legends
FMBP16BF		16			

Toggles
Rockers
Pushbuttons
Illuminated PB
Programmable
Keylocks
Rotaries
Slides
Tactiles
Tilt
Touch
Indicators
Accessories
Supplement

TYPICAL SWITCH DIMENSIONS

Nonilluminated • 4 or 16 Keys

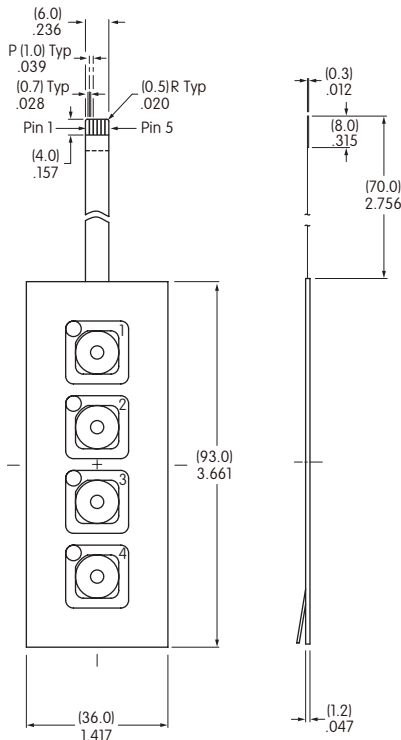

Switch Circuit Matrix For 4 Key

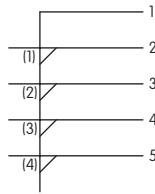

Key numbers in parenthesis are not actually on panel and are for reference only

Switch Circuit Matrix Detail For 4 or 16 Key

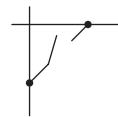

Switch Circuit Matrix For 16 Key

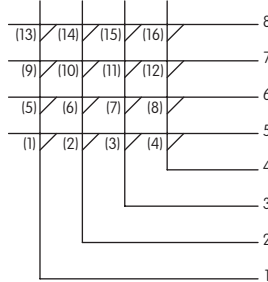

Key numbers in parenthesis are not actually on panel and are for reference only

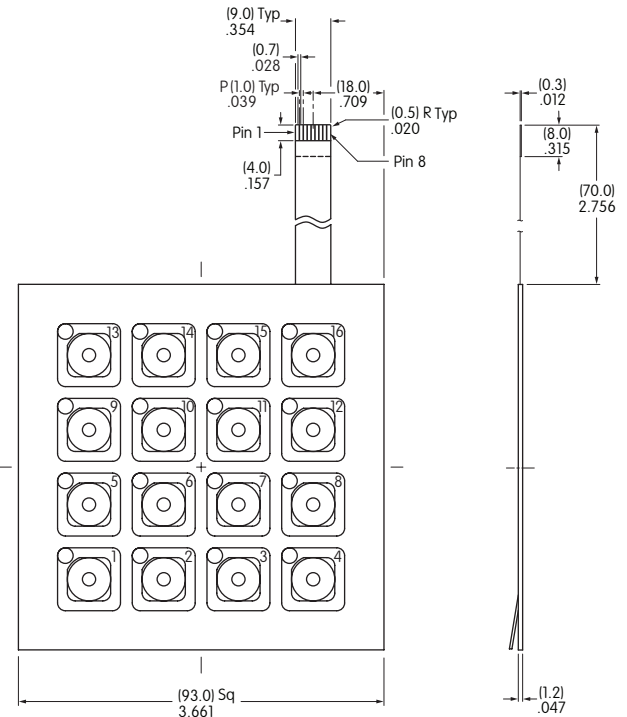

FMBN04BE
Gray
Surface
Sheet

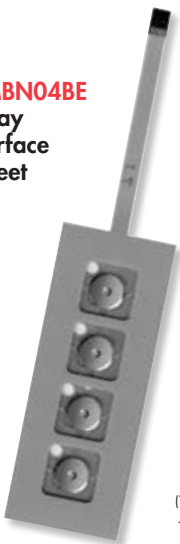

FMBN16BD
Black
Surface
Sheet

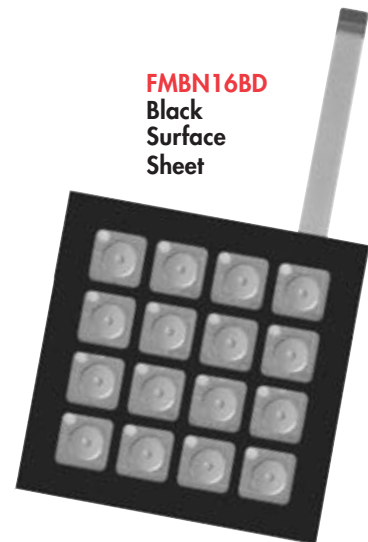

Insertable Legend Card for 4 Key or 16 Key

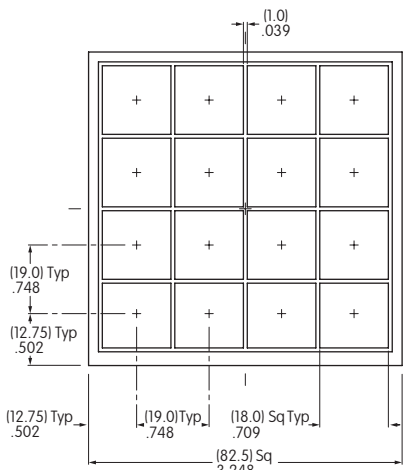
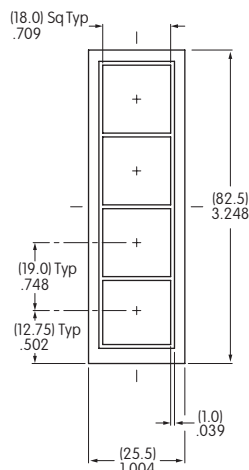

Insertable Legend Cards are supplied with the nonilluminated keypad assembly in Black, Gray and Yellow

Toggles

Rockers

Pushbuttons

Programmable Illuminated PB

Keylocks

Rotaries

Slides

Tactiles

Tilt

Touch

Indicators

Accessories

Supplement

TYPICAL SWITCH DIMENSIONS

Illuminated • 12 or 16 Keys

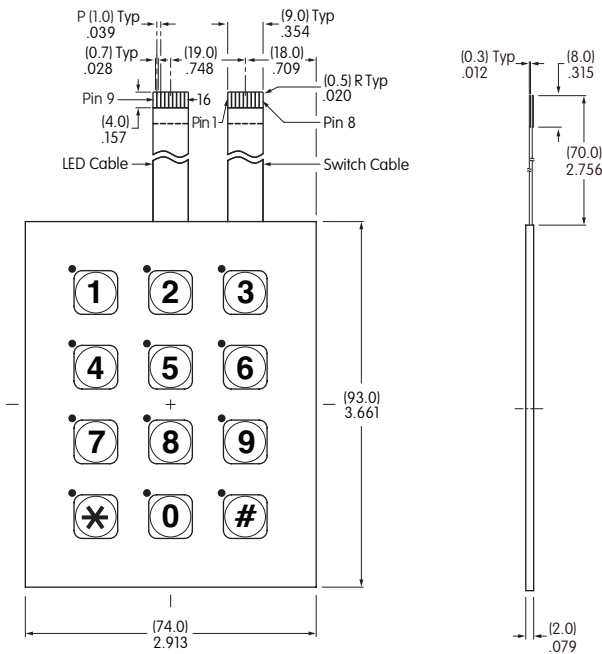

Dot illumination at upper left corner of each keypad

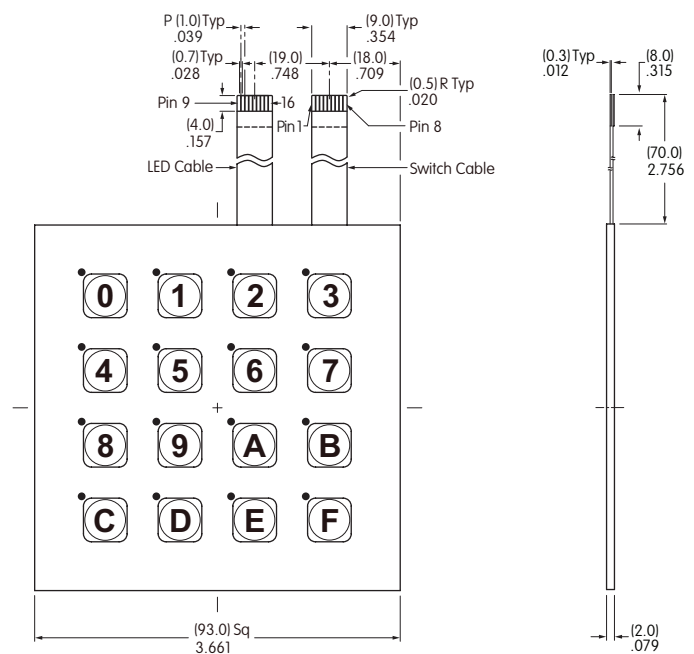

Dot illumination at upper left corner of each keypad

Switch Circuit Matrix For 12 Key

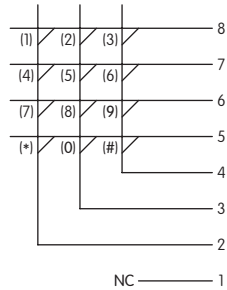

LED Circuit Matrix For 12 Key

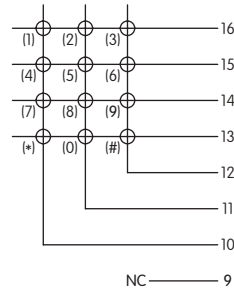

Switch Circuit Matrix For 16 Key

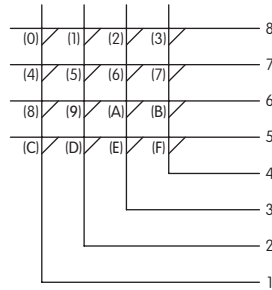

LED Circuit Matrix For 16 Key

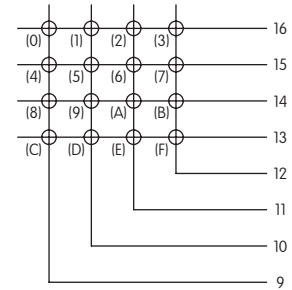

Key numbers in parenthesis are not actually on panel and are for reference only

FMBP12BF



Switch Circuit Matrix Detail For 12 or 16 Key

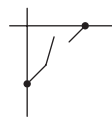

LED Circuit Matrix Detail For 12 or 16 Key

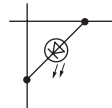

FMBP16BF



INSERTABLE LEGEND CARDS

Instructions for Customizing Insertable Legends

The membrane keypad assembly comes with three insertable legend cards: yellow, gray and black. The following provides guidelines for creating and insertion of legend cards for the membrane switch keypad assembly. Read all of the instructions prior to customizing and inserting the legend card.

- Using the borders on the insertable legend card as a guide, be sure characters on the card are about 1.5mm (.059") within these borders. This is the printable area.
- Legend characters may be drawn, printed, etc. Be sure that application choice is completely dry before inserting into membrane keypad assembly.

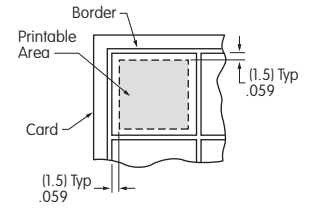

Instructions for Inserting Legend Card

- Note correct orientation of insertable legend card. Insert card under surface sheet, and use caution to avoid bending the membrane keypad assembly. Do not use pointed object to insert card, and do not remove surface sheet.
- Align and center all legend characters within the squares of the surface sheet.
- Smooth any wrinkles or air pockets from surface sheet.
- Peel off adhesive strip from the membrane keypad assembly.
- The legend card is now firmly in place and cannot be removed.
- Detach the protective film.

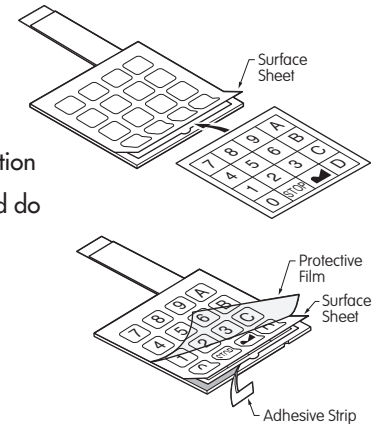

Connectors

Recommended Connectors for 5 Pin

Straight: FCI Part No. SLW5S-5C7LF
Right Angle: FCI Part No. SLW5R-5C7LF

Recommended Connectors for 8 Pin

Straight: FCI Part No. SLW8S-5C7LF
Right Angle: FCI Part No. SLW8R-5C7LF

PRECAUTIONS FOR HANDLING

- Assembly of legend card insert is handled by the customer. Therefore, we recommend to evaluate the finished product with the card assembled.
- Nonilluminated products have a loophole on each key. It is possible to add optional illumination by installing appropriate LEDs. Legend card does not have loopholes.
- To test proper electrical operation of switches, use of an electric buzzer is recommended.
- Use an additional chattering prevention circuit for the switch circuit.
- Do not operate switches with pointed objects (i.e. screwdrivers) to prevent perforation of film overlay.
- Use an FPC connector that corresponds to the printed circuit. Contact factory for suitable connectors.
- During assembly and installation of legends place devices on a level, sturdy surface. We do not recommend assembly and installation of device using a free hand or on a soft surface.
- Do not fold, bend, or apply pressure to the product.
- These devices contain adhesive that may emit noise. This does not affect product functionality.
- Do not depress any switch areas during assembly/installation.
- These membrane switches are built with air vents. Prior to installation, make corresponding holes to allow air vents to function. These holes should first be aligned with the membrane switch device, then made on the body of the final installation structure. Do not allow water or oil to penetrate through the air vents. Entry of any liquids through the air vents may cause contact failure.

APPLICATIONS

- Communication equipment
- Office machines
- Electronic equipment for national security
- Automation equipment
- Electronic equipment
- Amusement equipment