

General Specifications

Toggles

Rockers

Pushbuttons

Illuminated PB

Programmable

Keylocks

Rotaries

Slides

Tactiles

Tilt

Touch

Indicators

Accessories

Supplement

Electrical Capacity (Resistive Load)

Power Level (silver): 0.1A @ 30V DC

Logic Level (gold): 0.4VA maximum @ 28V AC/DC maximum
(Applicable Range 0.1mA ~ 0.1A @ 20mV ~ 28V)

Note: Find additional explanation of operating range in Supplement section.

Other Ratings

Contact Resistance: 20 milliohms maximum for power level; 40 milliohms maximum for logic level

Insulation Resistance: 100 megohms minimum @ 500V DC

Dielectric Strength: 500V AC minimum 1 minute minimum

Mechanical Life: 10,000 operations minimum

Electrical Life: 10,000 operations minimum

Contact Timing: SS12S & SS22S – Shorting (make-before-break)

Total Travel: .079" (2.0mm)

Materials & Finishes

Actuator: Polyamide

Upper Case: Polyester for 3-On models; polyacetal for all other models

Lower Case: Glass fiber reinforced polyester for 3-On models;
glass fiber reinforced polybutylene terephthalate (thermoplastic) for other models

Movable Contactor: Phosphor bronze with silver plating (code 2) or
phosphor bronze with gold plating (code 4)

Interior Base: Phenolic resin (thermoset)

Terminals: Brass with silver plating over copper plating or brass with gold plating

Environmental Data

Operating Temp Range: -15°C through +60°C (+5°F through +140°F)

Humidity: 90 ~ 95% humidity for 96 hours @ 40°C (104°F)

Vibration: 10 ~ 55Hz with peak-to-peak amplitude of 1.5mm traversing the frequency range & returning in 1 minute; 3 right angled directions for 2 hours

Shock: 50G (490m/s²) acceleration (tested in 6 right angled directions, with 5 shocks in each direction)

PCB Processing

Soldering: Wave Soldering: For non-supported through-hole, see Profile B in Supplement section.
For supported through-hole, 5 seconds maximum @ 250°C maximum.

Manual Solder: See Profile B in Supplement section.

Cleaning: These devices are not process sealed. Hand clean locally using alcohol based solution.

Standards & Certifications

The SS series devices have not been tested for UL recognition and CSA certification.

These switches are designed for use in a low-voltage, low-current circuit.

When used as intended in a low-voltage, low-current circuit, the results do not produce hazardous energy.

Distinctive Characteristics

Top or side actuation permits flexible board design.

Compact dimensions and low profile allow high density mounting and close stacking of PC boards.

Crisp actuation positively indicates circuit status.

Double molded thermoset base and thermo-plastic housing prevent loosening of terminals due to high soldering temperatures.

Award-winning STC mechanism with benefits unavailable in conventional mechanisms: smoother, positive detent actuation, increased contact stability, and unparalleled logic-level reliability. (Additional STC details in Terms and Acronyms in the Supplement section.)

Insert molded terminals lock out flux, solvents, and other contaminants.

Inch or metric terminal spacing for standard PC board grid (.100" x .100" or 2.0mm x 2.0mm).

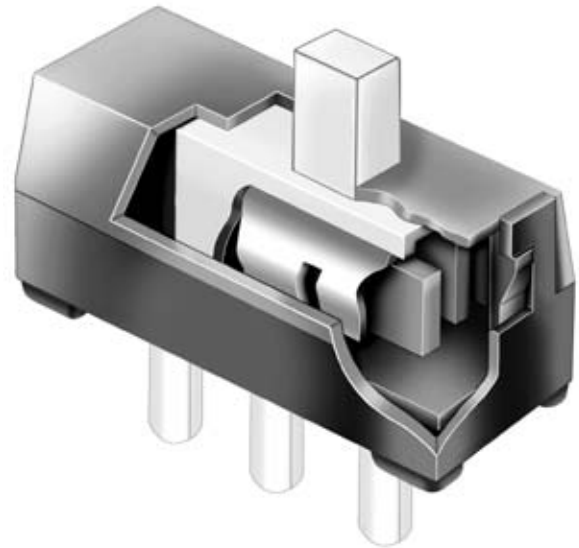

Actual Size

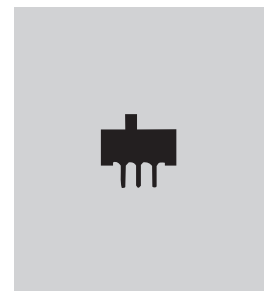

TYPICAL SWITCH ORDERING EXAMPLE

SS

12S

D

P

2

Poles & Circuits

12S	SPDT	ON	NONE	ON
SS12S model has shorting contacts.				
* 14M	SP3T	ON	ON	ON
22S	DPDT	ON	NONE	ON
SS22S model has shorting contacts.				
See Poles & Circuits chart below.				
* 14M Circuit with silver contacts only.				

Terminal Spacing

B	Metric 2.0mm x 2.0mm
D	Inch .100" x .100"

Contact Material & Ratings

2	Silver Rated 0.1A @ 30V DC
*4	Gold Rated 0.4VA maximum @ 28V AC/DC maximum
* Gold not available with SS14M.	

Actuation



P	Top Actuated
H	Side Actuated

DESCRIPTION FOR TYPICAL ORDERING EXAMPLE

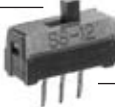
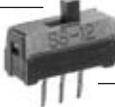
SS12SDP2

Top Actuated —  — SPDT ON-NONE-ON Circuit
 Silver Contacts Rated 0.1A @ 30V DC —  — Terminals with .100" Spacing

POLES & CIRCUITS

		Slide Position			Connected Terminals			Throw & Schematics
Pole	Model	Right	Center	Left	Right	Center	Left	
SP	SS12S	ON	NONE	ON	2-1	NONE	2-3	SPDT 
SP	SS14M	ON	ON	ON	3-4	3-2	3-1	SP3T  ON-OFF-ON circuit can be created by not connecting terminal 2.
DP	SS22S	ON	NONE	ON	2-1 5-4	NONE	2-3 5-6	DPDT 

TERMINAL SPACING

B Metric 2.0mm x 2.0mm with Black Base

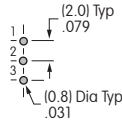
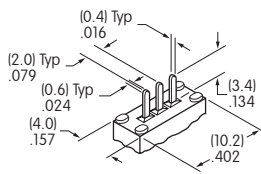

On-None-On Single Pole Models

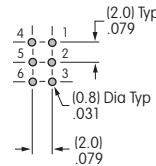
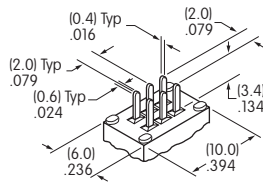

On-None-On Double Pole Models

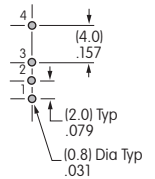
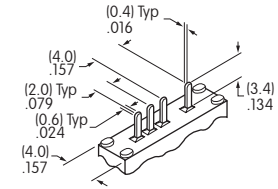

3-On Models

D Inch .100" x .100" with Gray Base

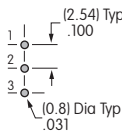
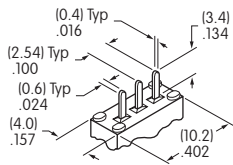

On-None-On Single Pole Models

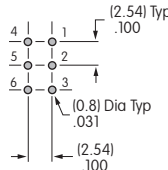
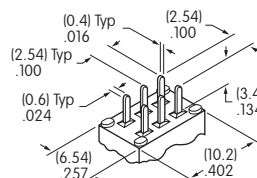

On-None-On Double Pole Models

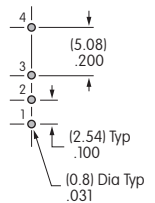
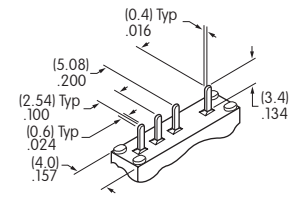

3-On Models

ACTUATION

P Top Actuated

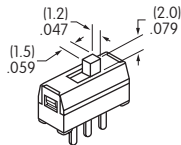

H Side Actuated

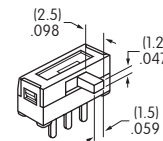

CONTACT MATERIALS & RATINGS

2 Silver over Phosphor Bronze

Power Level

0.1A @ 30V DC

4 Gold over Silver/Phosphor Bronze

Logic Level

0.4VA max @ 28V AC/DC max

Complete explanation of operating range in Supplement section.

TYPICAL SWITCH DIMENSIONS

Top Actuated

Single & Double Pole

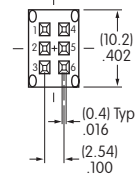
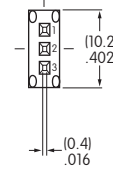
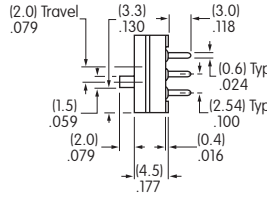
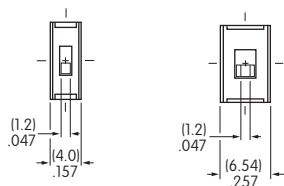

SS12SDP2

Side Actuated

Single & Double Pole

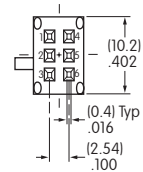
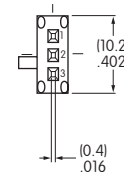
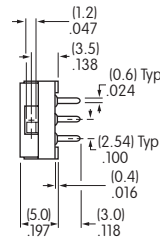
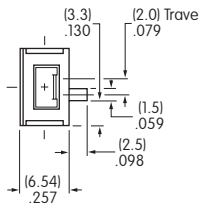
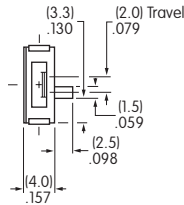

SS12SDH2

3-On Circuit • Top Actuated

Single Pole

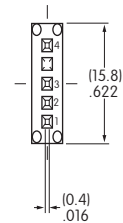
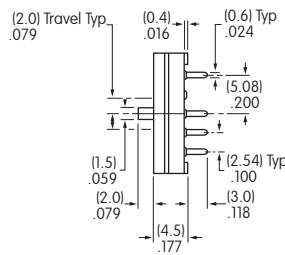
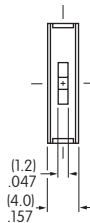

SS14MDP2

3-On Circuit • Side Actuated

Single Pole

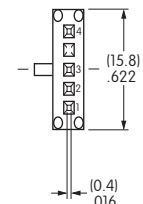
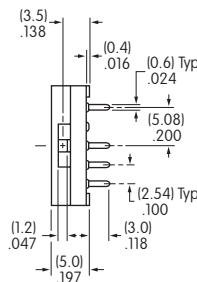
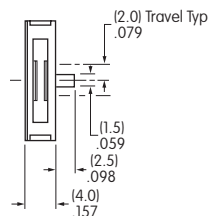

SS14MDH2

Toggle

Rockers

Pushbuttons

Illuminated PB

Programmable

Keylocks

Rotaries

Slides **H**

Tactiles

Tilt

Touch

Indicators

Accessories

Supplement