

General Specifications

Electrical Capacity (Resistive Load)

Logic Level: 0.4VA maximum @ 28V AC/DC maximum
(Applicable Range 0.1mA ~ 0.1A @ 20mV ~ 28V)
Note: Find additional explanation of operating range in Supplement section.

Other Ratings

Contact Resistance: 80 milliohms maximum
Insulation Resistance: 500 megohms minimum @ 500V DC
Dielectric Strength: 500V AC minimum for 1 minute minimum
Mechanical Life: 100,000 operations minimum
Electrical Life: 100,000 operations minimum
10,000 operations minimum @ 0.1A @ 28V AC/DC
Nominal Operating Force: 1.30N
Angle of Throw: 28°

Materials & Finishes

Actuator: Polyamide
Case: Glass fiber reinforced polyamide
Sealing Rings: Nitrile butadiene rubber
Movable Contacts: Phosphor bronze with gold plating
Stationary Contacts: Phosphor bronze with gold plating
Base: Glass fiber reinforced polyamide
Power Terminals: Phosphor bronze with gold plating
Lamp Terminals: Phosphor bronze with gold plating

Environmental Data

Operating Temperature Range: -25°C through +55°C (-13°F through +131°F)
Humidity: 90 ~ 95% humidity for 240 hours @ 40°C (104°F)
Vibration: 10 ~ 500Hz with peak-to-peak amplitude of 1.5mm traversing the frequency range & returning in 1 minute; 3 right angled directions for 2 hours
Shock: 50G (490m/s²) acceleration (tested in 6 right angled directions, with 5 shocks in each direction)

PCB Processing

Soldering: Wave Soldering recommended. See Profile A in Supplement section.
Manual Soldering: See Profile A in Supplement section.
Cleaning: Automated cleaning. See Cleaning specifications in Supplement section.

Standards & Certifications

The G Series toggles have not been tested for UL recognition or CSA certification. These switches are designed for use in a low-voltage, low-current, logic-level circuit. When used as intended in a logic-level circuit, the results do not produce hazardous energy.

Distinctive Characteristics

Fully illuminated toggle for highly visible status indication with LED in red, green, or amber for single color and red/green for bicolor.

Ultra-miniature size allows high density mounting, and extremely light weight makes these switches ideal for handheld equipment.

Totally sealed body construction prevents contact contamination and allows time- and money-saving automated soldering and cleaning.

Molded-in, epoxy sealed terminals lock out flux, solvents, and other contaminants.

Award-winning STC contact mechanism with benefits unavailable in conventional mechanisms: smooth, positive detent actuation, increased contact stability, and unparalleled logic-level reliability. (Additional STC details in Terms & Acronyms; see Supplement section.)

.100" x .100" (2.54mm x 2.54mm) terminal spacing conforms to standard PC board grid spacing. Round terminals facilitate easier through-hole mounting on PC boards.

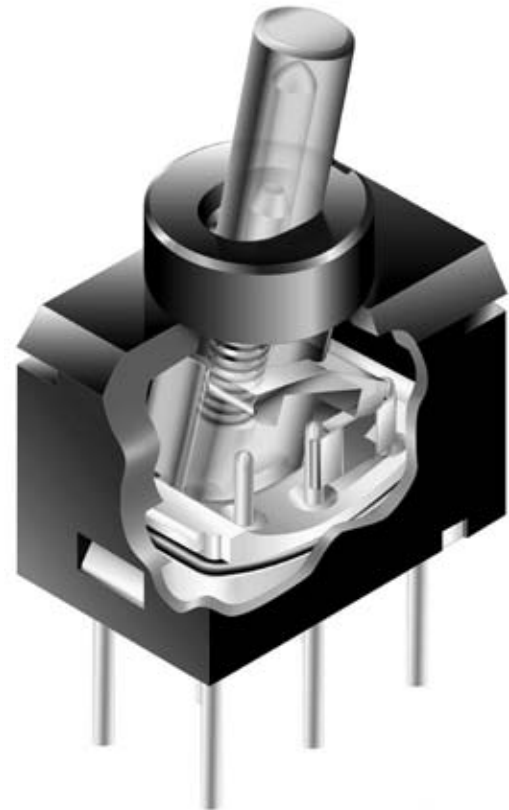

Actual Size

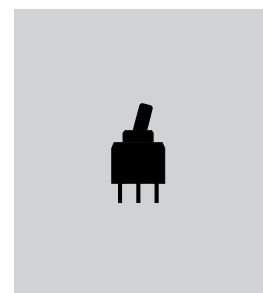

A

Toggles

Rockers

Pushbuttons

Illuminated PB

Programmable

Keylocks

Rotaries

Slides

Tactiles

Tilt

Touch

Indicators

Accessories

Supplement

TYPICAL SWITCH ORDERING EXAMPLE

G	1	2	J	H	C	
Pole	Circuits			Actuator	PC Terminals	LEDS
1 SPDT	2 ON NONE ON	Clear			P Straight	Single Color
	Combines with single color or bicolor LEDs				H Right Angle	C Red
	3 ON OFF ON				V Vertical	D Amber
	Combines with bicolor LED only					F Green
						ON-NONE-ON only
						Bicolor
						CF Red/Green
						ON-NONE-ON & ON-OFF-ON

DESCRIPTION FOR TYPICAL ORDERING EXAMPLE
G12JHC

SPDT — ON-NONE-ON Circuit — Clear Toggle, Red LED — Right Angle PC Terminals

POLES & CIRCUITS

Pole Throw	Model	Toggle Position			Connected Terminals			Schematics		
		Up	Center	Down	Up	Center	Down	Note: Terminal numbers are not actually on the switch. LED circuit is isolated and requires an external power source.		
SPDT	G12 G13	ON ON	NONE OFF	ON ON	2-3 2-3	NONE OPEN	2-1 2-1	 Single Color	 Bicolor	

ACTUATOR

J Clear Toggle

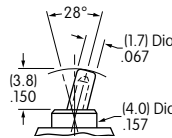

LED COLORS & SPECIFICATIONS

	Colors	Single Color			Bicolor
		C Red	D Amber	F Green	CF Red/Green
LEDs are an integral part of the switch and not available separately. The electrical specifications shown are determined at a basic temperature of 25°C.					
Maximum Forward Current	I_{FM}	30mA	30mA	25mA	30mA/25mA
Typical Forward Current	I_F	20mA	20mA	20mA	20mA/20mA
Forward Voltage	V_F	2.0V	2.0V	2.1V	2.0V/2.1V
Maximum Reverse Voltage	V_{RM}	5V	5V	5V	5V/5V
Current Reduction Rate Above 25°C	ΔI_F	0 - No current Reduction Rate within Ambient Temperature Range			
Ambient Temperature Range		-25° ~ +55°C			

If the source voltage exceeds the rated voltage, a ballast resistor is required.

The resistor value can be calculated by using the formula in the Supplement; see Supplement Index.

PC TERMINALS

P Straight

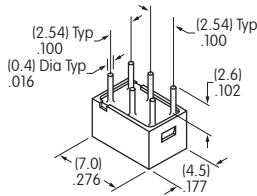

H Right Angle

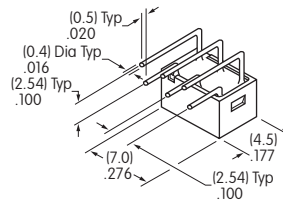

V Vertical

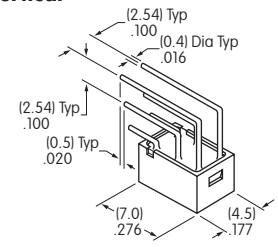

TYPICAL SWITCH DIMENSIONS

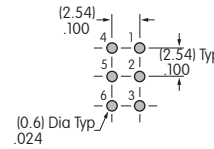
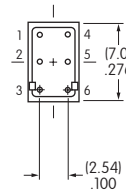
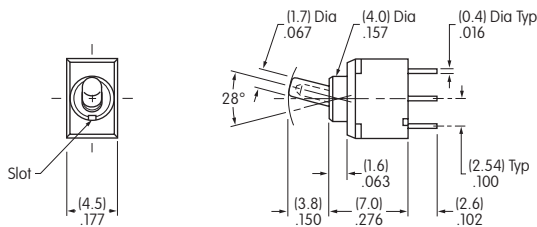

Straight PC



5 & 6 are LED terminals; 4 is a support pin on single color models & an LED terminal on bicolor models.

G12JPC

Right Angle PC

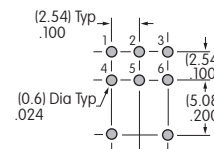
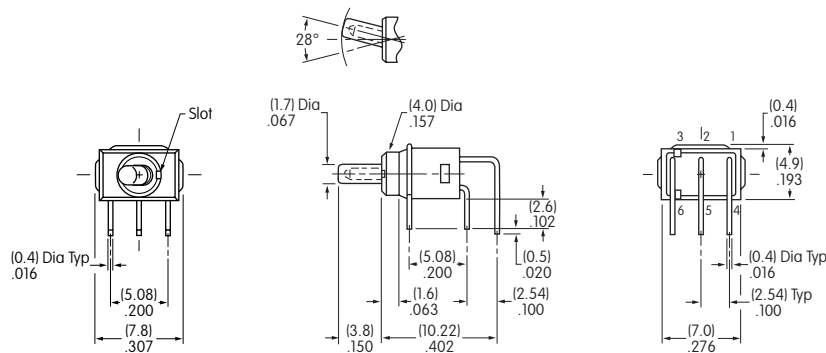

5 & 6 are LED terminals; 4 is a support pin on single color models & an LED terminal on bicolor models.

G12JHD

Vertical PC

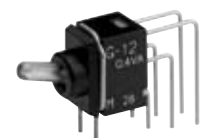
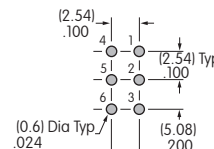
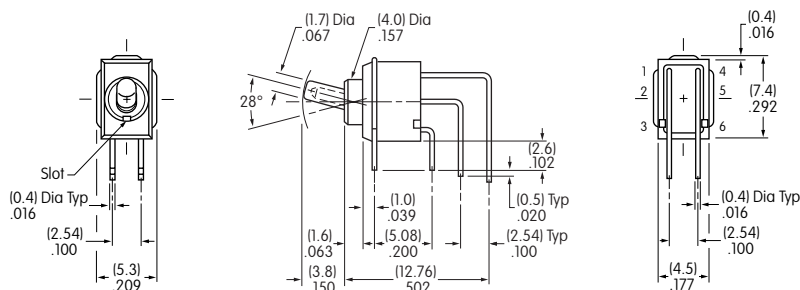

5 & 6 are LED terminals; 4 is a support pin on single color models & an LED terminal on bicolor models.

G12JVCF